

€ Senza IVA 61/2021
Valida fino al 31/01/2022



SUPEROFFERTA ***2021***



79%

Articolo	Pag	Articolo	Pag	Articolo	Pag	Articolo	Pag	Articolo	Pag	Articolo	Pag	
0												
001 RV	28	270 BM	83	426 D/S4	90	519 M 280HGTS	23	601 1/4-1/2 J100	59	922 BR1	97	
001 TRV	28	270 C/C3	83	426 SAB	90	519 M 280N1	23	601 1/4-1/2 J82	59	923 A	96	
002 JMA	24	272 DS	82	443 N	86	519 M 280TK	23	601 1/4-1/2 JTX16	58	926 A	67	
002 JTMA	25	276 CE/SE8	53	443 NC	86	519 M 285A1	23	606 1/2 EA	54	927 MN	83	
002 UDE	27	280 HAP/SE6	41	446 E/SE2	86	519 M 285A2	23	606 1/4 EA	54	928 AC1 1/2	94	
002 UDM	26	280 HATX/SE6	41	447 T	82	519 M 285KA	23	606 1/4 SK	57	928 D1 3/4	95	
007 FTSV	30	280 HG/SE6	41	451 N/S4	48	519 M 322H	23	608 1/4 EAK	56	929 PC1 1/2	92	
007 MLV	65	280 HGTS/SE6	41	454	48	519 M 322STX	23	609 1/4 EB	57	929 PC1/C12	93	
007 MV	65	280 LTS/S9	40	458 E/B9	46	519 M 324H	23	610 1/4 EFK	57	939 C1	96	
007 RV	31	280 LTSTX/S8	40	458 S20	47	519 M 324STX	23	612 1" ESI	55	942 PC3 1/2	92	
007 SV	30	280 T/SE7	42	458 S6	48	519 M 382F	23	612 1/2 MPA	55	942 PC3/C7	93	
007 TV	30	280 TK/SE6	43	460 A	48	519 M 613AEA	23	612 3/4 B	55	942 PD1 3/4	95	
007 V	31	280 TSTX/SE4	43	468 M	89	519 M 613BEA	23	612 3/4 EB	55	942 PE1 1	95	
007/1V	31	280 TTS/SE6	43	493 A	74	519 M 613CEA	23	622 K/S1	71	942 PEL2 1	95	
074 A	65	280 TTX/SE8	42	493 B	74	519 M 990A5MD	23	640 A	29	943 PC1 1/2	92	
076 G	65	280 XLTS/S9	40	493 C	74	519 R6/3A-S	13	641 TA	28	943 PC1/C12	93	
085 EX/SE2	38	283 SE9	52	495 098HYB	79	519 R6/3I-S	13	641 TB	28	943 PC2 1/2	94	
085 EX/SE3	38	285 DS8	50	495 A-PL	21	519 R6/3NV	11	641 TC	28	981 A	75	
091 D/SH5	34	285 KA/DS12	51	495 A-SP	20	519 R6/3V	11	646/5LV	29	984 MN	75	
091 SH5	34	285 KA/DS8	51	495 I-PL	21	519 R6/3VFULL	16	646/5V	29	987 E/S3	70	
091 SH8	34	285 KB/SR8	52	495 I-SP	20	519 R6/4NV	11	664 B/S7	45	987 F/S3	70	
098 3/8 HYB8	79	285 KF/DS8	52	495 MA	20	519 R6/4V	11	664 S25	45	988 D/S3	72	
100												
127 C/SE4	39	285 SE26	50	500		519 R6/5V	11	687 1/2 C16	98	988 E/S10	72	
127 C/SEAS	39	294 AC	49	501 P	19	519 R7/3V	11	688 3/4 MD6	98	988 G/S12	72	
127 N/SE4	39	294 AD	49	502 R2V	17	519 R8/3M-S	14	692 J32	44	988 LA/S14	72	
127 N/SE4S	39	294 AG	49	504 S	17	519 R8/3V	11	692 J49	44	988 MA/S19	72	
135 B	37	299 SE4	53	506 BA	18	519 RA1	16	692 J100	44	988 MA/S25	72	
146 B	64	299 SN/SE4	53	506 BAC	19	519 RA2	16	700			995 A	67
150 AX/SE2	36	300		506 BLC	19	519 RA3N	16	751	64	995 AF	66	
150 AX/SE3	36	305 N	62	513 B6V	17	519 RA4	16	753 KA	64	995 AL	66	
150 AX/SP2	37	307 A/S7	62	514 B6V	17	519 RA5	16	767	64	995 K	67	
155 AX	37	314 C	62	516 SA/C1	6	519 RA6	16	800			997 A	73
163	64	317 K	62	516 SA/C2	6	519 RA8	16	810 F	60	997 B	73	
178 N	37	322 SH10	35	516 SA/C3	7	519 RA9	16	810 N	60	1000		
200												
200 S	73	322 SH7	35	516 SA/C4	7	519/127N	22	810 N	60	1612 BA12	81	
207 D	63	322 STX/S7	35	516 SA/CA1	6	519/150AX	22	812 N	60	1612 BA24	81	
207 E	63	324 LPH	33	516 SA/CA2	6	519/276	22	814 A	61	1613 AGM 12-24	80	
218 N	71	324 SH12	33	516 SA/CA3	7	519/280HG	22	828 X4	61	1613 OBD	81	
233 1/2 MNTX/C6	98	324 SH5	32	516 SA/CA4	7	519/280HGTS	22	831 A	61	1613 RA12	80	
233 1/2 MXZN/C6	85	324 SH8	32	516 SP5HYB-S	79	519/280T	22	870 C	89	1651	81	
235 1/2 M/C16	99	324 STX/S7	33	516 SP6A-P	12	519/285A1	22	871 C	89	1785 B	91	
235 3/4 M/D7	99	333 K/S8	45	516 SP6I-P	12	519/285B2	22	871 D	89	1881 S22	81	
236 K 1/2	84	341 SH33	64	516 SP6NV	8	519/285KA1	22	884 C/S6	89	1950 C3	88	
236 K 1/4	84	367 SE6	68	516 SP6SV	10	519/294	22	885 F	89	1950 C6	88	
236 K/C13	84	372 SE6	69	516 SP6UD-796	15	519/322H	22	889 LTE	77	2000		
236 KE 1/2	84	374 N	69	516 SP6UD-894	15	519/322STX	22	889 RD	76	2000 A	91	
236 KE 1/4	84	376	69	516 SP6V	8	519/324H	22	889 RP	77	2550 A	88	
236 KE/C18	84	382	68	516 SP6XLM	14	519/324TX	22	889 RT	77	2550 B	88	
237 1/2 AK	56	382 F	68	516 SP6XLV	10	519/366	22	889 SA	76	2800 S21	85	
237 1/4 AK	56	400		516 SP7NV	8	519/382F	22	889 TR	76	2847 N4	85	
252 N/SR8	52	400 P	90	516 SP7V	8	519/613AEA	22	890 K	81	2847/3	85	
263 RA	87	421	71	516 SPC1	9	519/613BEA	22	900				
263 S16	87	421/120	71	516 SPC2	9	519/990A1	22	913 PB2 3/8	94	3000		
263 VAG	87	424 A2	70	516 SPCN1	9	532 A	29	913 PC2 1/2	94	3500 S1P	75	
		424 A3	70	516 SPCN2	9	532 B	29	920 AN1	96	3781 A	91	
		424 C2	70	519 M 091A	23	532 C	29	921 A4	96	3781 C	91	
		424 N4	70	519 M 127N	23	532 D	29	922 B1	97	3781 D	91	
		425 TPMS	83	519 M 150AX	23	600			922 B2	97	3781 E	91
		426 B/S5	90	519 M 276	23	601 1/2 J22	58	922 BL1	97			
		426 C/S4	90	519 M 280HG	23	601 1/4 J34	58	922 BP1	97			

SCOPRI LE NOVITÀ 2021



NEW

Arredamento 516 Start
Pagina 6



NEW

Pneumatica
Pagina 92



NEW

Bussole macchina
Pagina 98



NEW

Carrelli
Pagina 8



NEW

Carrelli assortiti
Pagina 12



NEW

Banchi da lavoro
Pagina 18

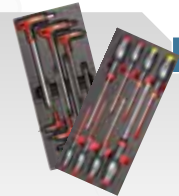

NEW

Assortimenti
Pagina 20



NEW

Valigie manutenzione
Pagina 24



Contenitori trasportabili
Pagina 28



NEW

Giraviti
Pagina 32



Pinze
Pagina 36



NEW

Chiavi maschio e inserti
Pagina 40



Estrattori
Pagina 46



Chiavi di manovra
Pagina 49



NEW

Cricchetti e bussole
Pagina 54



Serraggio controllato
Pagina 60



Idraulica
Pagina 62



Forbici per elettricisti
Pagina 63



Elettrotecnica
Pagina 64



Rivettatrici
Pagina 66



Manutenzione
Pagina 68



NEW

Illuminazione
Pagina 76



NEW

Autoriparazione
Pagina 78



CERCA GLI ICONIC PRODUCT:
i prodotti che fanno la differenza!

NUOVA LINEA ARREDAMENTO START 516

Una nuova gamma modulare per creare facilmente postazioni di lavoro professionali.



SEMPLICE ED ESSENZIALE

16 componenti per allestire nel modo in cui preferisci la tua postazione.
Configurabile in due altezze: 842 mm o 1006 mm (piano di lavoro).

QUALITA' DELLA GAMMA START

Design e materiali della gamma di carrelli portautensili
USAG START 516.

Componenti forniti montati e pronti per l'allestimento.

COMPATIBILE CON LA MODULARITA' USAG

I cassetti sono compatibili con il sistema di moduli in spugna
o termoformato presenti a Catalogo.



CONFIGURATORE ONLINE



start516.usag.it



**Il configuratore online ti aiuta a realizzare in modo semplice
la tua postazione professionale su misura.**

**Provalo subito: vai su start516.usag.it
o clicca sul banner nella Home Page del sito usag.it**



516 SA/C1

Cod. U05160231



Pianale in legno
1.450 mm
516 SAL/1

Arredamento per officina - pianale in legno

- Fornita con kit base di 30 ganci 516 SA/K1.

~~€ 1.614,00~~ | **€ 1.149,00**



516 SA/CA1

Cod. U05160235



Pianale in acciaio
1.450 mm
516 AC/1

Arredamento per officina - pianale in acciaio

- Fornita con kit base di 30 ganci 516 SA/K1.

~~€ 1.614,00~~ | **€ 1.149,00**



DESCRIZIONE	ART	PZ
Mobile fisso con 6 cassetti	516 SA/1	1
Mobile fisso con 2 ante	516 SA/2	1
Pannello forato portautensili	516 SA/5	6
Rialzo per mobili	516 SA/11	2
Lampada a LED	516 SA/12	2
Ripiano metallico	516 SA/13	2
Kit di montaggio	516 SA/14	2
Kit di 30 ganci per pannelli	516 SA/K1	1



**Include:
ganci e lampade LED**



516 SA/C2

Cod. U05160232



Pianale in legno
1.450 mm
516 SAL/1

Arredamento per officina - pianale in legno

- Fornita con kit base di 30 ganci 516 SA/K1.

~~€ 2.498,00~~ | **€ 1.769,00**



516 SA/CA2

Cod. U05160236



Pianale in acciaio
1.450 mm
516 AC/1

Arredamento per officina - pianale in acciaio

- Fornita con kit base di 30 ganci 516 SA/K1.

~~€ 2.498,00~~ | **€ 1.769,00**



DESCRIZIONE	ART	PZ
Mobile fisso con 6 cassetti	516 SA/1	1
Mobile fisso con 2 ante	516 SA/2	1
Armadio a 1 anta	516 SA/3	1
Pensile con anta basculante	516 SA/4	2
Pannello forato portautensili	516 SA/5	3
Pannello forato portautensili con 6 prese SCHUKO	516 SA/6	1
Rialzo per mobili	516 SA/11	3
Lampada a LED	516 SA/12	2
Kit di montaggio	516 SA/14	2
Kit di 30 ganci per pannelli	516 SA/K1	1



**Include:
ganci, lampade LED
e presa multipla**

GURAZIONE IDEALE!



516 SA/C3

Cod. U05160233



Pianale in legno
2.175 mm
516 SAL/2

Arredamento per officina - pianale in legno

- Fornita con kit base di 30 ganci 516 SA/K1.

~~€ 3.410,00~~ | **€ 2.399,00**



516 SA/CA3

Cod. U05160237



Pianale in acciaio
2.175 mm
516 AC/2

Arredamento per officina - pianale in acciaio

- Fornita con kit base di 30 ganci 516 SA/K1.

~~€ 3.410,00~~ | **€ 2.399,00**

NEW

**Include:
ganci, lampade LED
e presa multipla**



DESCRIZIONE	ART	PZ
Mobile fisso con 6 cassetti	516 SA/1	1
Mobile fisso con 2 ante	516 SA/2	1
Armadio a 1 anta	516 SA/3	1
Pensile con anta basculante	516 SA/4	3
Pannello forato portautensili	516 SA/5	5
Pannello forato portautensili con 6 prese SCHUKO	516 SA/6	1
Rialzo per mobili	516 SA/11	3
Lampada a LED	516 SA/12	2
Kit di montaggio	516 SA/14	3
Kit di 30 ganci per pannelli	516 SA/K1	1
Carrello - 6 cassetti	516 SA/16	1



516 SA/C4

Cod. U05160234



Pianale in legno
2.175 mm
516 SAL/2

Arredamento per officina - pianale in legno

- Fornita con kit base di 30 ganci 516 SA/K1.

~~€ 1.857,00~~ | **€ 1.319,00**



516 SA/CA4

Cod. U05160238



Pianale in acciaio
2.175 mm
516 AC/2

Arredamento per officina - pianale in acciaio

- Fornita con kit base di 30 ganci 516 SA/K1.

~~€ 1.857,00~~ | **€ 1.319,00**

NEW

**Include:
ganci, lampade LED
e presa multipla**



DESCRIZIONE	ART	PZ
Mobile fisso con 6 cassetti	516 SA/1	1
Mobile fisso con 2 ante	516 SA/2	1
Pannello forato portautensili	516 SA/5	8
Pannello forato portautensili con 6 prese SCHUKO	516 SA/6	1
Rialzo per mobili	516 SA/11	2
Lampada a LED	516 SA/12	2
Ripiano metallico	516 SA/13	3
Kit di montaggio	516 SA/14	3
Kit di 30 ganci per pannelli	516 SA/K1	1



YouTube

START 516



Nuovo colore
disponibile!



Nuovo colore
disponibile!



7
CASSETTI

3
MODULI

● 516 SP7V

Cod. U05160007



Carrello START (vuoto)

- Dimensioni interne cassetti:
 - 5 cassetti 570x420x60 mm.
 - 1 cassetto 570x420x130 mm.
 - 1 cassetto 570x420x200 mm.

€ ~~680,00~~ | € **439,00**

● 516 SP7NV

Cod. U05160012

NEW

Carrello START (vuoto)

€ ~~680,00~~ | € **439,00**

**MANIGLIE
BASCULANTI IN ABS**



6
CASSETTI

3
MODULI

● 516 SP6V

Cod. U05160006



Carrello START (vuoto)

- Dimensioni interne cassetti:
 - 3 cassetti 570x420x60 mm.
 - 2 cassetti 570x420x130 mm.
 - 1 cassetto 570x420x200 mm.

€ ~~597,00~~ | € **399,00**

● 516 SP6NV

Cod. U05160008

NEW

Carrello START (vuoto)

€ ~~597,00~~ | € **399,00**



RISPARMIA IL TUO TEMPO

Tutti i carrelli a cassetteria USAG sono subito pronti all'uso, perchè forniti con le ruote già montate alla struttura.



1000 kg



ACCIAIO

6

CASSETTI

3

MODULI

516 SPC2
Cod. U05160021



Banco da lavoro START con piano in acciaio

- Dimensioni interne cassetti:
 - 3 cassetti 570x420x60 mm.
 - 2 cassetti 570x420x130 mm.
 - 1 cassetto 570x420x200 mm.

~~€ 1.132,00~~ | **€ 759,00**

Nuovo colore
disponibile!



2000 mm

516 SPCN2 **NEW**
Cod. U05160023

Banco da lavoro START con piano in acciaio

~~€ 1.132,00~~ | **€ 759,00**

Piano in acciaio zincato

Trattato anticorrosione e con bordi anticaduta da 37 mm.

1000 kg



LEGNO

6

CASSETTI

3

MODULI

516 SPC1
Cod. U05160020



Banco da lavoro START con piano in legno

- Dimensioni interne cassetti:
 - 3 cassetti 570x420x60 mm.
 - 2 cassetti 570x420x130 mm.
 - 1 cassetto 570x420x200 mm.

~~€ 1.132,00~~ | **€ 759,00**

Nuovo colore
disponibile!



2000 mm

516 SPCN1 **NEW**
Cod. U05160022

Banco da lavoro START con piano in legno

~~€ 1.132,00~~ | **€ 759,00**

Piano in faggio multistrato

Lo spessore di 40 mm garantisce il top della resistenza.



6
CASSETTI

4
MODULI

516 SP6XLV

Cod. U05160011

 90 kg	 mm	 969 971 517
---	--	---

Carrello Start XL (vuoto)

- Dimensioni interne cassetti:
 - 3 cassetti 760x420x60 mm.
 - 2 cassetti 760x420x130 mm.
 - 1 cassetto 760x420x270 mm.

€ 751,00 | **€ 495,00**

**MANIGLIE
BASCULANTI IN ABS**



6
CASSETTI

3
MODULI

516 SP6SV

Cod. U05160013

 60 kg	 mm	 748 970 515
---	--	---

Carrello START con sistema antiribaltamento (vuoto)

- Dimensioni interne:
 - 3 cassetti 570x420x60 mm.
 - 2 cassetti 570x420x130 mm.
 - 1 cassetto 570x420x200 mm.

€ 693,00 | **€ 485,00**



Sistema antiribaltamento
che permette di aprire un solo
cassetto per volta.

Racing 519



YouTube



519 R6/3V
Cod. U05190414
Carrello RACING (vuoto)

519 R6/4V
Cod. U05190419
Carrello RACING (vuoto)

519 R6/3NV
Cod. U05190424
Carrello RACING (vuoto)

519 R6/4NV
Cod. U05190429
Carrello RACING (vuoto)

519 R6/5V
Cod. U05190420
Carrello RACING (vuoto)

- Dimensioni interne:
 - 4 cassetti 570x420x60 mm.
 - 1 cassetto 570x420x130 mm.
 - 1 cassetto 570x420x270 mm.

- Dimensioni interne:
 - 4 cassetti 760x420x60 mm.
 - 1 cassetto 760x420x130 mm.
 - 1 cassetto 760x420x270 mm.

- Dimensioni interne:
 - 3 cassetti 950x420x60 mm.
 - 2 cassetti 950x420x130 mm.
 - 1 cassetto 950x420x200 mm.

€ 990,00 | **€ 693,00**

€ 1.152,00 | **€ 806,00**

€ 1.486,00 | **€ 1.040,00**



519 R7/3V
Cod. U05190415
Carrello RACING (vuoto)

519 R8/3V
Cod. U05190416
Carrello RACING (vuoto)

- Dimensioni interne:
 - 5 cassetti 570x420x60 mm.
 - 1 cassetto 570x420x130 mm.
 - 1 cassetto 570x420x200 mm.

- Dimensioni interne:
 - 6 cassetti 570x420x60 mm.
 - 2 cassetti 570x420x130 mm.

€ 1.086,00 | **€ 760,00**

€ 1.181,00 | **€ 827,00**



RISPARMIA IL TUO TEMPO

Tutti i carrelli a cassettera USAG sono subito pronti all'uso, perchè forniti con le ruote già montate alla struttura.



Carrelli con assortimento

NON TROVI IL
Vai subito su



RISPARMI
€ 100

Rispetto all'acquisto di carrello ed assortimento separati.

177
PEZZI

516 SP6I-P
Cod. U05168020

Carrello START con assortimento MANUTENZIONE - 4 cassette

€ 1.778,50 | **€ 909,00**



RISPARMI
€ 100

Rispetto all'acquisto di carrello ed assortimento separati.

151
PEZZI

516 SP6A-P
Cod. U05168021

Carrello START con assortimento AUTORIPARAZIONE - 3 cassette

€ 1.696,00 | **€ 869,00**

ASSORTIMENTO MANUTENZIONE

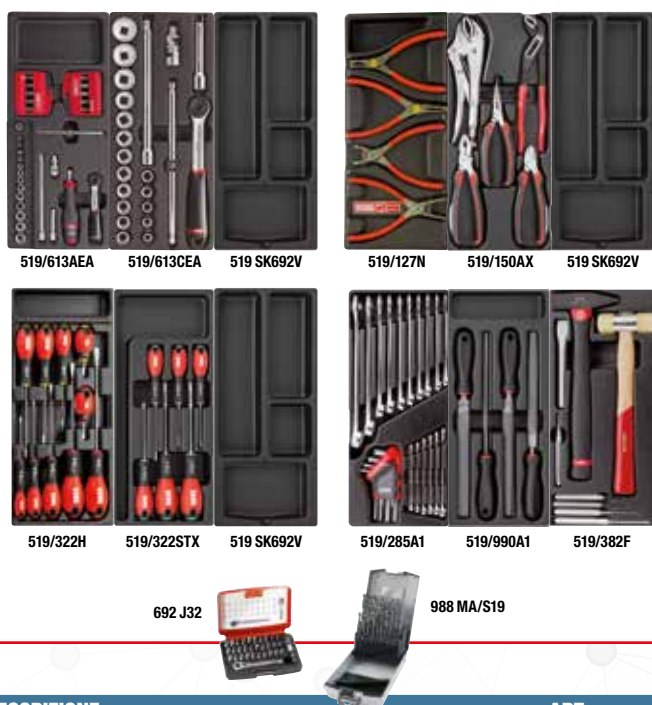

ASSORTIMENTO AUTORIPARAZIONE

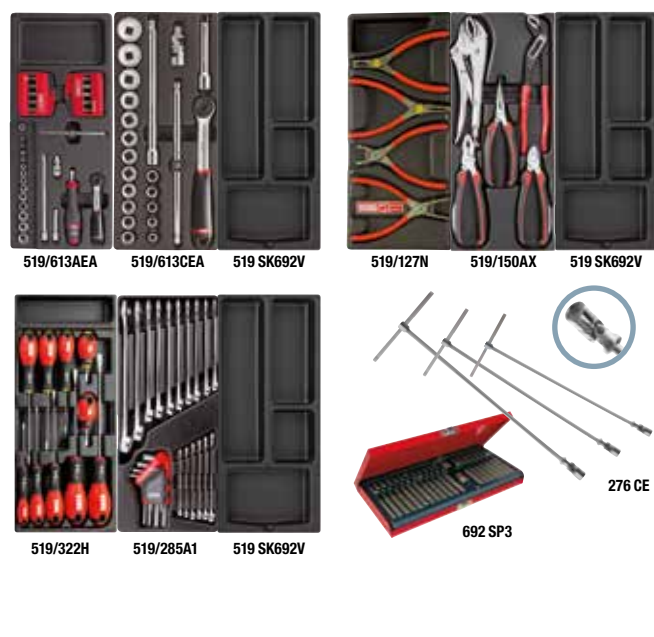

DESCRIZIONE	ART	PZ
Bussole esagonali, cricchetto (237 A 1/4"), accessori 1/4" ed inserti	519/613AEA	42
Bussole esagonali, cricchetto (237 A 1/2") e accessori 1/2"	519/613CEA	22
Pinze per anelli elastici (19-60 mm)	519/127N	4
Pinza universale, pinza regolabile, tronchese, pinza becchi lunghissimi, pinza grip	519/150AX	5
Giraviti a taglio e croce PH	519/322H	10
Giraviti TORX® Tamper Resistant (T10-T15-T20-T-25-T30-T40)	519/322STX	6
Chiavi combinate (6-7-8-9-10-11-12-13-14-15-16-17-18-19-22-24 mm)	519/285A1	25
Lima piatta, mezzotonda, tonda e triangolare	519/990A1	4
Martello, Mazzuola, Scalpelli e cacciaspine	519/382F	8
Assortimento di punte HSS-G	988 MA/S19	19
Assortimento di inserti con cricchetto reversibile	692 J32	32

DESCRIZIONE	ART	PZ
Bussole esagonali, cricchetto (237 A 1/4"), accessori 1/4" ed inserti	519/613AEA	42
Bussole esagonali, cricchetto (237 A 1/2") e accessori 1/2"	519/613CEA	22
Pinze per anelli elastici (19-60 mm)	519/127N	4
Pinza universale, pinza regolabile, tronchese, pinza becchi lunghissimi, pinza grip	519/150AX	5
Giraviti a taglio e croce PH	519/322H	10
Chiavi combinate (6-7-8-9-10-11-12-13-14-15-16-17-18-19-22-24 mm)	519/285A1	25
Assortimento di inserti RIBE con foro - XZN - TORX® Tamper Resistant	692 SP3	40
Chiavi a T snodate con bocca esagonale (10,13,17 mm)	276 CE	3

TUO ASSORTIMENTO IDEALE?

kitplanner.usag.it e realizzalo!



RISPARMI
€ 230

Rispetto all'acquisto di carrello ed assortimento separati.



RISPARMI
€ 230

Rispetto all'acquisto di carrello ed assortimento separati.

157
PEZZI

519 R6/3I-S
Cod. U05198022

Carrello RACING con assortimento MANUTENZIONE - 3 cassetti

~~€ 2.047,50~~ | **€ 1.129,00**

149
PEZZI

519 R6/3A-S
Cod. U05198023

Carrello RACING con assortimento AUTORIPARAZIONE - 3 cassetti

~~€ 2.149,50~~ | **€ 1.069,00**

ASSORTIMENTO MANUTENZIONE



ASSORTIMENTO AUTORIPARAZIONE



DESCRIZIONE	ART	PZ
Bussole esagonali, cricchetto (237 A 1/4"), accessori 1/4" ed inserti	519 M 613AEA	46
Bussole esagonali, cricchetto (237 A 1/2") e accessori 1/2"	519 M 613CEA	23
Chiavi combinate (6-7-8-9-10-11-12-13-14-15-16-17-18-19-22-24 mm)	519 M 285A1	17
Pinza universale, pinza regolabile, tronchese, pinza becchi lunghissimi, pinza grip	519 M 150AX	5
Giraviti a taglio e croce PH	519 M 324H	8
Giraviti TORX® Tamper Resistant (T10-T15-T20-T25-T30-T40)	519 M 324STX	7
Assortimento di punte HSS-G	988 MA/S19	19
Assortimento di inserti con cricchetto reversibile	692 J32	32

DESCRIZIONE	ART	PZ
Bussole esagonali, cricchetto (237 A 1/4"), accessori 1/4" ed inserti	519 M 613AEA	46
Bussole esagonali, cricchetto (237 A 1/2") e accessori 1/2"	519 M 613CEA	23
Chiavi combinate (6-7-8-9-10-11-12-13-14-15-16-17-18-19-22-24 mm)	519 M 285A1	17
Pinza universale, pinza regolabile, tronchese, pinza becchi lunghissimi, pinza grip	519 M 150AX	5
Giraviti a taglio e croce PH	519 M 324H	8
Giraviti TORX® Tamper Resistant (T10-T15-T20-T25-T30-T40)	519 M 324STX	7
Assortimento di inserti RIBE con foro - XZN - TORX® Tamper Resistant	692 SP3	40
Chiavi a T snodate con bocca esagonale (10,13,17 mm)	276 CE	3

Vuoi solo l'assortimento? Vai a pagina 20

NON TROVI IL
Vai subito su



RISPARMI
€ 200

Rispetto all'acquisto di carrello ed assortimento separati.

318
PEZZI

516 SP6XLM

Cod. U05160111

Carrello **START XL** con assortimento **MANUTENZIONE - 4 cassetti**

~~€ 3.149,00~~ | **€ 1.619,00**



NEW



RISPARMI
€ 300

Rispetto all'acquisto di carrello ed assortimento separati.

318
PEZZI

519 R8/3M-S

Cod. U05198024

Carrello **RACING** con assortimento **MANUTENZIONE - 6 cassetti**

~~€ 3.620,00~~ | **€ 1.849,00**



ASSORTIMENTO MANUTENZIONE



519 M 612CLA

519 M 613BEA

519 M 613AEA



519 M 285KA

519 M 285A1

519 M 285A2

519 M 233C24

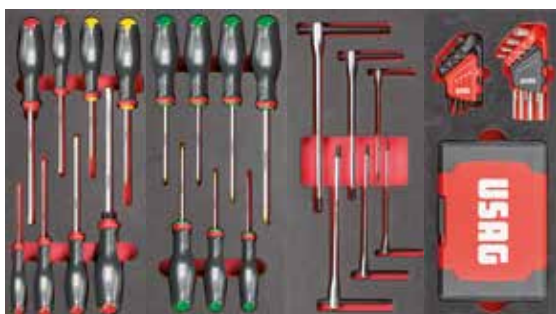

519 M 324H

519 M 324STX

519 M 280TK

519 M 280N1



519 M 127N

519 M 150AX

519 M 382F

519 M 990A5MD

DESCRIZIONE	ART	PZ
Bussole esagonali, cricchetto (237 A 1/4"), accessori 1/4" ed inserti	519 M 613AEA	46
Bussole esagonali, cricchetto (237 A 3/8") e accessori 3/8"	519 M 613BEA	20
Bussole poligonali, cricchetto (237 A 1/2") e accessori 1/2"	519 M 612CLA	35
Chiavi combinate (6-7-8-9-10-11-12-13-14-15-16-17-18-19-22-24 mm)	519 M 285A1	17
Chiavi combinate (27-29-30-32-34 mm)	519 M 285A2	5
Chiavi combinate a cricchetto reversibile (8-9-10-11-12-13-14-15-16-17-18-19-mm)	519 M 285KA	12
Chiavi a bussola TORX® e con inserto TORX®, XZN, esagonale, Ribe	519 M 233 C24	24
Giraviti a taglio e croce PH	519 M 324H	8

DESCRIZIONE	ART	PZ
Giraviti TORX® Tamper Resistant (T10-T15-T20-T25-T30-T40)	519 M 324STX	7
Chiavi maschio a T con traversino scorrevole (2,5-3-4-5- 6-8 mm)	519 M 280TK	6
Cassetta inserti assortita e chiavi maschio esagonali - TORX®	519 M 280N1	117
Pinze per anelli elastici interni ed esterni 19÷60	519 M 127N	4
Pinza universale, pinza regolabile, tronchese, pinza becchi lunghissimi, pinza grip	519 M 150AX	5
Lime a taglio mezzodolce	519 M 990A5MD	5
Martello per meccanici, mazzuola, cacciaspine, scalpello e bulino	519 M 382F	7

TUO ASSORTIMENTO IDEALE? kitplanner.usag.it e realizzalo!



Incluso
trapano
avvitatore

**INSIEME
UNICI**

223
PEZZI

516 SP6UD-796

Cod. U05161796W

Carrello START con assortimento
MANUTENZIONE - 4 cassetti



~~€ 2.164,04~~ | **€ 999,00**



Incluso
avvitatore
ad impulsi

**INSIEME
UNICI**

122
PEZZI

516 SP6UD-894

Cod. U05161894W

Carrello START con assortimento
AUTORIPARAZIONE - 4 cassetti



~~€ 2.408,43~~ | **€ 999,00**

ASSORTIMENTO MANUTENZIONE



519 M 613AEA 519 M 613CEA 519 MSK6



519 M 324H 519 M 324STX 519 MSK6



519 M 285A1 519 M 150AX 519 MSK6



519 M 280N1

18V XR

Alloggiamenti liberi
per 2^a e 3^a batteria  **DCD796**
(1 batteria inclusa)

ASSORTIMENTO AUTORIPARAZIONE



519 M 613AEA 519 M 613CEA 519 MSK6



519 M 324H 519 M 324STX 519 MSK6



519 M 285A1 519 M 150AX 519 MSK6



519 M 236K

18V XR

Alloggiamenti liberi
per 2^a e 3^a batteria  **DCF894**
(1 batteria inclusa)

DESCRIZIONE	ART	PZ
Bussole esagonali, cricchetto (237 A 1/4"), accessori 1/4" ed inserti	519 M 613AEA	46
Bussole esagonali, cricchetto (237 A 1/2") e accessori 1/2"	519 M 613CEA	23
Chiavi combinate (6-7-8-9-10-11-12-13-14-15-16-17-18-19-22-24 mm)	519 M 285A1	17
Pinza universale, pinza regolabile, tronchese, pinza becchi lunghissimi, pinza grip	519 M 150AX	5
Giraviti a taglio e croce PH	519 M 324H	7
Giraviti TORX® Tamper Resistant (T10-T15-T20-T25-T30-T40)	519 M 324STX	8
Cassetta inserti assortita e chiavi maschio esagonali - TORX®	519 M 280N1	117
Caricabatterie universale XR Litio	DCB115	1
Trapano avvitatore con percussione	DCD796	1

DESCRIZIONE	ART	PZ
Bussole esagonali, cricchetto (237 A 1/4"), accessori 1/4" ed inserti	519 M 613AEA	46
Bussole esagonali, cricchetto (237 A 1/2") e accessori 1/2"	519 M 613CEA	23
Chiavi combinate (6-7-8-9-10-11-12-13-14-15-16-17-18-19-22-24 mm)	519 M 285A1	17
Pinza universale, pinza regolabile, tronchese, pinza becchi lunghissimi, pinza grip	519 M 150AX	5
Giraviti a taglio e croce PH	519 M 324H	7
Giraviti TORX® Tamper Resistant (T10-T15-T20-T25-T30-T40)	519 M 324STX	8
Cassetta inserti assortita e chiavi maschio esagonali - TORX®	519 M 280N1	117
Caricabatterie universale XR Litio	DCB115	1
Avvitatore ad impulsi 1/2" con batteria	DCF894	1



6
CASSETTI

3
MODULI

519 R6/3V FULL

Cod. U05191414

Carrello RACING - Full optional (vuoto)

- Dimensioni interne:
 - 4 cassetti 570x420x60 mm.
 - 1 cassetto 570x420x130 mm.
 - 1 cassetto 570x420x270 mm.

€ 1.475,50 | **€ 793,00**

COMPLETO DI:

- Pannello superiore.
- Piano appoggio pieghevole.
- Portarotolo.
- Portaflaconi (x2).

NEW

86 kg | 774 mm | 1.400 mm | 546 mm

RISPARMI
€ 240

Rispetto all'acquisto di carrello ed accessori separati.

ACCESSORI CARRELLI



519 RA1

Cod. U05190207

Portarifiuti
per Racing, Start, Booster e Bull.

€ 88,00 | **€ 62,00**



519 RA2

Cod. U05190208

Portadocumenti
per Racing, Start, Booster e Bull.

€ 48,80 | **€ 34,20**



519 RA3N

Cod. U05190212

Pannello superiore
per Racing (3 moduli).

€ 138,00 | **€ 97,00**

NEW



519 RA4

Cod. U05190210

Portarotolo
per Racing, Start, Booster e Bull.

€ 53,50 | **€ 37,50**



519 RA5

Cod. U05190211

Portaflaconi
per Racing, Start, Booster e Bull.

€ 77,50 | **€ 54,50**



519 RA6

Cod. U05190217

Piano appoggio pieghevole
per Racing.

€ 139,00 | **€ 97,50**



519 RA8

Cod. U05190219

Supporto per documenti
per Racing.

€ 55,50 | **€ 38,90**



519 RA9

Cod. U05190218

Piano in legno per morsa
per Racing.

€ 139,00 | **€ 97,50**



1100 kg

6
CASSETTI

3
MODULI

94 kg | mm | 1154
1000
546

513 B6V

Cod. U05130096

Carrello BOOSTER (vuoto)

- Dimensioni interne:
 - 4 cassetti 570x420x60 mm.
 - 1 cassetto 570x420x130 mm.
 - 1 cassetto 570x420x270 mm.
- Vano laterale: 380x400x720 mm.



~~€ 1.485,00~~ | **€ 1.040,00**



200 kg

3
RIPIANI

18 kg | mm | 750
950
450

504 S

Cod. U05040003

Carrello multiuso

- Ripiani protetti con materiale plastico ad alta resistenza.
- Maniglia in acciaio per una maggiore manovrabilità.
- Due ruote pivotanti (Ø 100 mm) e due ruote fisse (Ø 100 mm).
- Fornito smontato.

~~€ 166,00~~ | **€ 122,00**



1000 kg

6
CASSETTI

3
MODULI

128 kg | mm | 1.212
1000
670

514 B6V

Cod. U05140001

Banco da lavoro mobile BULL (vuoto)

- Piano di lavoro in legno multistrato.
- Portata massima cassetti: 20 kg.
- Vano laterale: 380x704x524 mm.
- Dimensioni interne:
 - 3 cassetti 570x420x60 mm.
 - 2 cassetti 570x420x130 mm.
 - 1 cassetto 570x420x200 mm.



~~€ 1.888,00~~ | **€ 1.322,00**



45 kg | mm | 720
1.000
280

2
CASSETTI



502 R2V

Cod. U05020003

Armadio vuoto - 2 cassetti

- Pannelli forati interni.
- Apertura a 180° delle ante.
- Cassetto ad estrazione totale.
- Guide telescopiche a sfera.
- Maniglia cassetto in alluminio anodizzato.
- Chiusura a serratura centralizzata.
- Possibilità di ancoraggio a parete o posizionamento su carrelli Racing 519R a 3 moduli (con kit tubi di montaggio U50100193).
- Ante verniciate colore rosso RAL 3020.
- Ganci e supporti non inclusi.
- Dimensioni interne cassetti: 569x210x60 mm.

ANTE CON DOPPIO PANNELLO

~~€ 939,00~~ | **€ 657,00**



ACCIAIO

NEW

506 BA

Banco da lavoro con piano in acciaio

- Piano in lamiera d'acciaio zincata (spessore 2,5 mm) con bordi anticaduta altezza 37 mm.
- Ripiano inferiore d'appoggio incluso.
- Predisposizione per il fissaggio al pavimento.
- Struttura in lamiera d'acciaio verniciata, colore nero RAL 9004.
- 4 montanti per le lunghezze 1 m e 1,5 m.
- 6 montanti per la lunghezza 2 m.
- Possibilità di montare il cassetto 506 U130.

CODICE	L (mm)	P (mm)	H (mm)	📦	
U05060014	1.000	700	850	50 kg	€ 237,00 € 166,00
U05060015	1.500	700	850	63 kg	€ 336,00 € 235,00
U05060016	2.000	700	850	85 kg	€ 420,00 € 294,00



LEGNO

NEW

506 BL

Banco da lavoro con piano in legno

- Piano in legno multistrato (spessore 40 mm) integrato nella struttura.
- Ripiano inferiore d'appoggio incluso.
- Predisposizione per il fissaggio al pavimento.
- Struttura in lamiera d'acciaio verniciata, colore nero RAL 9004.
- 4 montanti per le lunghezze 1 m e 1,5 m.
- 6 montanti per la lunghezza 2 m.
- Possibilità di montare il cassetto 506 U130.

CODICE	L (mm)	P (mm)	H (mm)	📦	
U05060004	1.000	700	850	55 kg	€ 340,00 € 238,00
U05060005	1.500	700	850	69 kg	€ 459,00 € 321,00
U05060006	2.000	700	850	93 kg	€ 550,00 € 385,00

Piano in faggio multistrato

Lo spessore di 40 mm garantisce il top della resistenza.

Piano in acciaio zincato

Trattato anticorrosione e con bordi anticaduta da 37 mm.

NEW

ACCIAIO

2 CASSETTI

2000 kg



106 kg | 2.000 mm | 850 mm | 700 mm

506 BAC/2000

Cod. U05060034

Banco da lavoro con piano in acciaio

- Piano in lamiera d'acciaio zincata (spessore 2,5) con bordi anticaduta altezza 37 mm.
- Ripiano inferiore d'appoggio incluso.
- Predisposizione per il fissaggio al pavimento.
- Struttura in lamiera d'acciaio verniciata, colore nero RAL 9004.
- 6 montanti.
- 2 cassetti con serratura montati su guide telescopiche, colore rosso RAL 3020.
- Dimensione interna cassetti: 570x420x175 mm.

~~€ 636,00~~ | **€ 439,00**

NEW

LEGNO

2 CASSETTI

2000 kg



109 kg | 2.000 mm | 850 mm | 700 mm

506 BLC/2000

Cod. U05060024

Banco da lavoro con piano in legno

- Piano in legno multistrato (spessore 40 mm).
- Ripiano inferiore d'appoggio incluso.
- Predisposizione per il fissaggio al pavimento.
- Struttura in lamiera d'acciaio verniciata, colore nero RAL 9004.
- 6 montanti.
- 2 cassetti con serratura montati su guide telescopiche, colore rosso RAL 3020.
- Dimensione interna cassetti: 570x420x175 mm.

~~€ 780,00~~ | **€ 546,00**

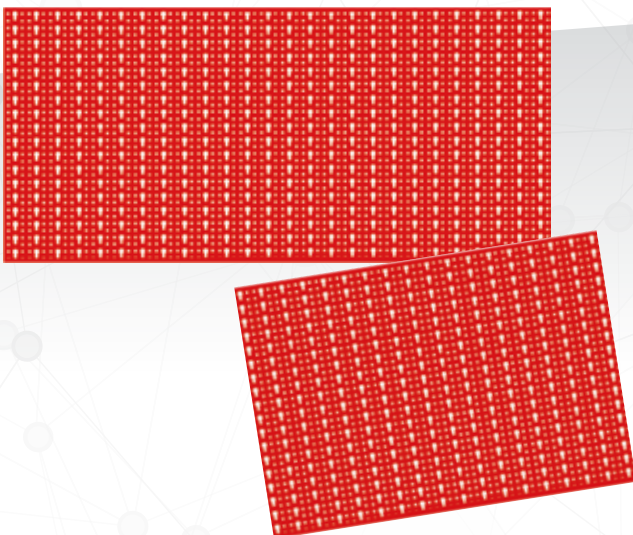

501 P

Pannelli forati

- Diametro fori 5 mm.
- Lamiera di acciaio, spessore 1,2 mm.
- Esecuzione verniciata colore rosso RAL 3020.
- Utilizzabile con ganci serie 552÷559.

CODICE	L (mm)	H (mm)	kg	€
U05010103Q	1.000	800	9,5 kg	€ 90,50 € 63,50
U05010104Q	1.500	800	13,5 kg	€ 152,00 € 106,00
U05010105Q	2.000	800	17,5 kg	€ 174,00 € 122,00

MODULI IN SPUGNA BICOLORE



519 M 613AEA 519 M 613CEA 519 MSK6



519 M 285A1 519 M 150AX 519 MSK6

157
PEZZI

495 I-SP

Cod. U04950622

Assortimento **INDUSTRIA** - 3 cassetti



DESCRIZIONE	ART	PZ
Bussole esagonali, cricchetto (237 A 1/4"), accessori 1/4" ed inserti	519 M 613AEA	46
Bussole esagonali, cricchetto (237 A 1/2") e accessori 1/2"	519 M 613CEA	23
Chiavi combinate (6-7-8-9-10-11-12-13-14-15-16-17-18-19-22-24 mm)	519 M 285A1	17
Pinza universale, pinza regolabile, tronchese, pinza becchi lunghissimi, pinza grip	519 M 150AX	5
Giraviti a taglio e croce PH	519 M 324H	8
Giraviti TORX® Tamper Resistant (T10-T15-T20-T25-T30-T40)	519 M 324STX	7
Assortimento di punte HSS-G	988 MA/S19	19
Assortimento di inserti con cricchetto reversibile	692 J32	32

~~€ 1.057,50~~ | **€ 666,00**



519 M 324H 519 M 324STX 519 MSK6



988 MA/S19

692 J32



519 M 613AEA 519 M 613CEA 519 MSK6



519 M 285A1 519 M 150AX 519 MSK6

149
PEZZI

495 A-SP

Cod. U04950623

Assortimento **AUTORIPARAZIONE** - 3 cassetti



DESCRIZIONE	ART	PZ
Bussole esagonali, cricchetto (237 A 1/4"), accessori 1/4" ed inserti	519 M 613AEA	46
Bussole esagonali, cricchetto (237 A 1/2") e accessori 1/2"	519 M 613CEA	23
Chiavi combinate (6-7-8-9-10-11-12-13-14-15-16-17-18-19-22-24 mm)	519 M 285A1	17
Pinza universale, pinza regolabile, tronchese, pinza becchi lunghissimi, pinza grip	519 M 150AX	5
Giraviti a taglio e croce PH	519 M 324H	8
Giraviti TORX® Tamper Resistant (T10-T15-T20-T25-T30-T40)	519 M 324STX	7
Assortimento di inserti RIBE con foro - XZN - TORX® Tamper Resistant	692 SP3	40
Chiavi a T snodate con bocca esagonale (10,13,17 mm)	276 CE	3

~~€ 1.159,50~~ | **€ 606,00**



519 M 324H 519 M 324STX 519 MSK6

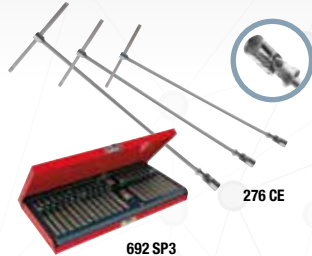

276 CE

692 SP3

ASSORTIMENTO PER CARRELLI 4 MODULI



519 M 612CLA 519 M 613BEA 519 M 613AEA



519 M 285KA 519 M 285A1 519 M 285A2 519 M 233C24

318
PEZZI

495 MA

Cod. U04950023

Assortimento **ANUTENZIONE**
4 cassetti

~~€ 2.398,00~~ | **€ 1.324,00**

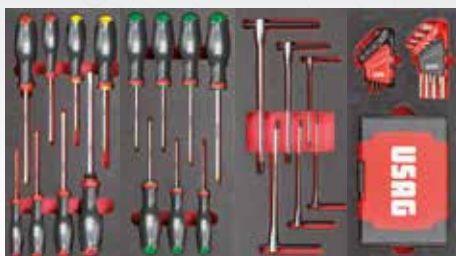

519 M 324H 519 M 324STX 519 M 280TK 519 M 280N1



519 M 127N 519 M 150AX 519 M 382F 519 M 990A5MD

MODULI IN PLASTICA



519/613AEA 519/613CEA 519 SK692V



519/127N 519/150AX 519 SK692V



519/322H 519/322STX 519 SK692V



519/285A1 519/990A1 519/382F



692 J32



988 MA/S19



519/613AEA 519/613CEA 519 SK692V



519/127N 519/150AX 519 SK692V



519/322H 519/285A1 519 SK692V

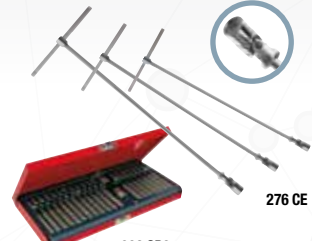

692 SP3

DESCRIZIONE	ART	PZ
Bussole esagonali, cricchetto (237 A 1/4"), accessori 1/4" ed inserti	519 M 613AEA	46
Bussole esagonali, cricchetto (237 A 3/8") e accessori 3/8"	519 M 613BEA	20
Bussole esagonali, cricchetto (237 A 1/2") e accessori 1/2"	519 M 612CLA	35
Chiavi combinate (6-7-8-9-10-11-12-13-14-15-16-17-18-19-22-24 mm)	519 M 285A1	17
Chiavi combinate (27-29-30-32-34 mm)	519 M 285A2	5
Chiavi combinate a cricchetto reversibile (8-9-10-11-12-13-14-15-16-17-18-19 mm)	519 M 285KA	12
Chiavi a bussola TORX® e con inserto TORX®, XZN, esagonale, Ribe	519 M 233 C24	24
Giraviti a taglio e croce PH	519 M 324H	8
Giraviti TORX® Tamper Resistant (T10-T15-T20-T25-T30-T40)	519 M 324STX	7
Chiavi maschio a T con traversino scorrevole 2,5-8 mm	519 M 280TK	6
Cassetta inserti assortita e chiavi maschio esagonali - TORX®	519 M 280N1	117
Pinze per anelli elastici interni ed esterni 19-60	519 M 127N	4
Pinza universale, pinza regolabile, tronchese, pinza becchi lunghissimi, pinza grip	519 M 150AX	5
Lime a taglio mezzodolce	519 M 990A5MD	5
Martello per meccanici, mazzuola, cacciaspine, scalpello e bulino	519 M 382F	7

177
PEZZI

495 I-PL
Cod. U04950620



Assortimento **INDUSTRIA** - 4 cassette

DESCRIZIONE	ART	PZ
Bussole esagonali, cricchetto (237 A 1/4"), accessori 1/4" ed inserti	519/613AEA	42
Bussole esagonali, cricchetto (237 A 1/2") e accessori 1/2"	519/613CEA	22
Pinze per anelli elastici (19-60 mm)	519/127N	4
Pinza universale, pinza regolabile, tronchese, pinza becchi lunghissimi, pinza grip	519/150AX	5
Giraviti a taglio e croce PH	519/322H	10
Giraviti TORX® Tamper Resistant (T10-T15-T20-T25-T30-T40)	519/322STX	6
Chiavi combinate (6-7-8-9-10-11-12-13-14-15-16-17-18-19-22-24 mm)	519/285A1	25
Lima piatta, mezzotonda, tonda e triangolare	519/990A1	4
Martello, Mazzuola, Scalpelli e cacciaspine	519/382F	8
Assortimento di punte HSS-G	988 MA/S19	19
Assortimento di inserti con cricchetto reversibile	692 J32	32

~~€ 1.153,00~~ | € 610,00

151
PEZZI

495 A-PL
Cod. U04950621



Assortimento **AUTORIPARAZIONE** - 4 cassette

DESCRIZIONE	ART	PZ
Bussole esagonali, cricchetto (237 A 1/4"), accessori 1/4" ed inserti	519/613AEA	42
Bussole esagonali, cricchetto (237 A 1/2") e accessori 1/2"	519/613CEA	22
Pinze per anelli elastici (19-60 mm)	519/127N	4
Pinza universale, pinza regolabile, tronchese, pinza becchi lunghissimi, pinza grip	519/150AX	5
Giraviti a taglio e croce PH	519/322H	10
Chiavi combinate (8-6-7-8-9-10-11-12-13-14-15-16-17-18-19-22-24 mm)	519/285A1	25
Assortimento di inserti RIBE con foro - XZN - TORX® Tamper Resistant	692 SP3	40
Chiavi a T snodate con bocca esagonale (10,13,17 mm)	276 CE	3

~~€ 1.070,00~~ | € 570,00



NON TROVI IL TUO ASSORTIMENTO IDEALE?

Vai subito su
kitplanner.usag.it
e realizzalo!

Moduli in plastica



519/127N
Cod.U05190716

4
PEZZI

127 N 19÷60 · 127 PN 19÷60 ·
128 N 19÷60 · 128 PN 19÷60.

€ 94,50 | € 66,50



519/150AX
Cod.U05190850

5
PEZZI

133 AX 160 · 134 250 · 150 AX 180 ·
180 C 250 · 188 AX 160.

€ 140,50 | € 98,50



519/280HG
Cod.U05191860

7
PEZZI

280 HG 3-4-5-6-7-8-10 mm.

€ 97,50 | € 68,50



519/280HGTS
Cod.U05191861

7
PEZZI

280 HGTS 3-4-5-6-7-8-10 mm.

€ 106,50 | € 75,00



519/285A1
Cod.U05190785

25
PEZZI

285 6-7-8-9-10-11-12-13-14-15-16-17-
18-19-22-24 280 S9 1,5÷10.

€ 155,50 | € 109,00



519/285B2
Cod.U05190823

4
PEZZI

285 27-29-30-32.

€ 88,50 | € 62,00



519/285KA1
Cod.U05190788

12
PEZZI

285 KA 8-9-10-11-12-13-14-15-
16-17-18-19.

€ 209,00 | € 146,00



519/294
Cod.U05190732

9
PEZZI

204 250 · 294 A 250 · 367 2x110-3x130-
4x145-5x165-6x180-8x200 · 981 A3.

€ 104,00 | € 73,00



519/322H
Cod.U05190772

10
PEZZI

322 0,5x3x75-0,8x4x100-1x5,5x125-
1,2x6,5x150-1,6x8x175 · 322 PH 0x75-1x100-
2x125 · 322 N 0,8x4x30 · 322 NPH 2x30.

€ 51,50 | € 36,10



519/322STX
Cod.U05190831

6
PEZZI

322 STX T10-T15-T20-T25-T30-T40.

€ 49,00 | € 34,30



519/324H
Cod.U05190763

10
PEZZI

324 0,5x3x75-0,8x4x100-1x5,5x125-
1,2x6,5x150-1,2x8x200 · 324 PH 0x75-1x75-
2x100 · 324 N 0,8x4x35 · 324 NPH 2x35.

€ 66,50 | € 46,60



519/324TX
Cod.U05190764

9
PEZZI

324 TX T6x50-T7x50-T8x50-T9x75 · 324 STX
T10x75-T15x75-T20x100-T25x100-T30x125.

€ 93,70 | € 65,50



519/366
Cod.U05190740

7
PEZZI

351 200 · 362 125-150 · 364 125 ·
366 3x125 · 4x150 · 368 4x125.

€ 68,50 | € 48,00



519/382F
Cod.U05190742

8
PEZZI

362 150 · 367 2x110-3x130-4x145-
5x165 · 368 4x125 · 376 35 · 382F 500.

€ 86,00 | € 60,50



519/613AEA
Cod.U05190784

42
PEZZI

235 1/4" EN 4-4,5-5-5,5-6-7-8-9-10-11-12-13-
14 · 236 1/4" 50-150 · 237 A 1/4" · 240 1/4" ·
241 1/4" · 243 1/4" · 692 S11 · 692 STX/S11 ·
684 1/4"-1/4".

€ 178,50 | € 125,00



519/613BEA
Cod.U05190747

21
PEZZI

235 3/8" E 6-7-8-9-10-11-12-13-14-15-
16-17-18-19-21-22 · 236 3/8" 125-250 ·
237 A 3/8" · 240 3/8" N · 241 3/8".

€ 182,50 | € 128,00



519/613CEA
Cod.U05190750

22
PEZZI

235 1/2" EN 10-11-12-13-14-15-16-
17-18-19-20-21-22-24-27-30-32 · 236
1/2" 125-250 · 237 A 1/2" · 240 1/2" N ·
241 1/2".

€ 219,50 | € 154,00



519/990A1
Cod.U05190825

4
PEZZI

990 M PA/200 · 990 M PB/200
990 M PC/200 · 990 M PE/200.

€ 49,50 | € 34,70



8
PEZZI

XXL

519/276
Cod.U05190725

276 CE 7-8-10-11-13-14-17-19.

€ 250,50 | € 175,00



8
PEZZI

XL

519/280T
Cod.U05190727

280 T 2-2,5-3-4-5-6-8-10.

€ 134,00 | € 94,00



CREA IL TUO
Questa è solo
disponib

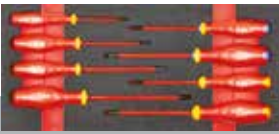

519 M 091A
Cod.U05191016

8
PEZZI

091 0,5x3x75-0,8x4x100-1x5,5x125
1,2x6,5x150 · 091 PH 1x100-2x125
· 091 PZ 1x100-2x125.

€ 79,50 | € 56,00



519 M 280HGTS
Cod.U05191946

7
PEZZI

280 HGTS 3-4-5-6-7-8-10 mm.

€ 106,50 | € 75,00



519 M 285A2
Cod.U05190943

5
PEZZI

285 27-29-30-32-34.

€ 128,00 | € 90,00



519 M 324H
Cod.U05190910

8
PEZZI

324 0,5x3x75-0,8x4x100-1x5,5x125-
1,2x6,5x150 · 324 PH 1x100-2x125
324 D 0,6x3,5x100 324 E 1,6x8x175.

€ 63,00 | € 44,10



519 M 127N
Cod.U05190937

4
PEZZI

127 N 19÷60 · 127 PN 19÷60 ·
128 N 19÷60 · 128 PN 19÷60.

€ 99,50 | € 70,00



519 M 280N1
Cod.U05191013

117
PEZZI

280 S9 1,5-2-2,5-3-4-5-6-8-10 · 280 TX/
S8C T10-T15-T20-T25-T27-T30-T40-T45
· 692 J100.

€ 114,00 | € 80,00



519 M 285KA
Cod.U05190944

12
PEZZI

285 KA 8-9-10-11-12-13-14-15-
16-17-18-19.

€ 214,00 | € 150,00



519 M 150AX
Cod.U05190965

5
PEZZI

133 AX 160 · 134 250 · 150 AX 180 ·
180 C 250 · 188 AX 160.

€ 145,50 | € 102,00



519 M 280TK
Cod.U05190935

6
PEZZI

280 TK 2,5-3-4-5-6-8.

€ 103,50 | € 72,50



519 M 322H
Cod.U05190927

8
PEZZI

322 0,5x3x75-0,8x4x100-1x5,5x125-
1,2x6,5x150-1,6x8x175 · 322 PH 0x75-
1x100-2x125.

€ 47,00 | € 32,90



519 M 280HG
Cod.U05191945

7
PEZZI

280 HG 3-4-5-6-7-8-10 mm.

€ 97,50 | € 68,50



519 M 285A1
Cod.U05190921

17
PEZZI

285 6-7-8-9-10-11-12-13-14-15-16-
17-18-19-21-22-24.

€ 157,00 | € 110,00



519 M 322STX
Cod.U05190929

6
PEZZI

322 STX T10x75-T15x75-T20x100-
T25x100-T30x125-T40x125.

€ 54,00 | € 37,80



519 M 324STX
Cod.U05190911

7
PEZZI

324 STX T10x75-T15x75-T20x100-
T25x100-T27x100-T30x125-T40x150.

€ 94,00 | € 66,00



519 M 382F
Cod.U05190926

7
PEZZI

362 175 · 367 2x100-3x130-6x180
368 3x100 · 376 28 · 382F 500.

€ 105,00 | € 73,50



519 M 613AEA
Cod.U05190940

46
PEZZI

235 1/4" EN 5,5-6-7-8-9-10-11-12-13-14-
236 1/4" 50-100 · 237 A 1/4" · 240 1/4"
· 241 1/4" · 243 1/4" · 280 LTS/S9 · 684
1/4"-1/4" · 660 0,6-1-1,6 · 660 E 3-4-5-6-
8 · 660 PH 1-2-3 · 660 PZ 1-2-3 · 660 STX
T15-T20-T25-T27-T30-T40.

€ 212,00 | € 148,00



519 M 613BEA
Cod.U05190928

20
PEZZI

235 3/8" E 7-8-9-10-11-12-13-14-15-16-
17-18-19-21-22 · 236 3/8" 125-250 ·
237 A 3/8" · 240 3/8" N · 241 3/8".

€ 182,00 | € 127,00



519 M 613CEA
Cod.U05190942

23
PEZZI

235 1/2" EN 8-10-11-12-13-14-15-16-
17-18-19-21-22-23-24-27-30-32 · 236
1/2" 125-250 · 237 A 1/2" · 240 1/2" N
· 241 1/2".

€ 230,50 | € 161,00



519 M 990A5MD
Cod.U05191011

5
PEZZI

990 M PA/200 · 990 M PB/200 · 990 M
PC/200 · 990 M PD/200 · 990 M PE/200.

€ 66,00 | € 46,20



7
PEZZI

XXL

519 M 276
Cod.U05190936

276 CE 7-8-10-11-13-17-19.

€ 231,00 | € 162,00

ASSORTIMENTO IDEALE:
una selezione dei 200 moduli
ili su kitplanner.usag.it

Valigia per manutenzione

11 kg | 460 mm | 158 mm | 385 mm

002 JMA

Cod. U00020011

Valigia con assortimento per manutenzione

- Valigia con struttura in profilato di Alluminio.
- Doppia cerniera di chiusura in metallo con serratura.
- 3 pannelli portautensili interni con elastici di tenuta.
- Base con interno in mousse bicolore sagomata.

~~€ 619,50~~ | **€ 360,00**



181
PEZZI



**CONTIENE LE PINZE SERIE AX,
I GIRAVITI 324
E LA CHIAVE A RULLINO 294 AD!**

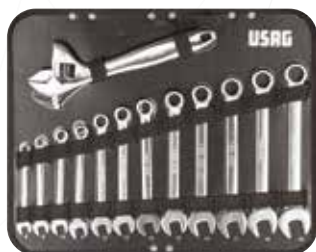

DESCRIZIONE	MISURA	PZ.	DESCRIZIONE	MISURA	PZ.
Chiavi a bussola 1/2" con bocca esagonale	10-11-12-13-14-15-16-17-18-19-21-22-24-27-30-32 mm	16	Giravite cercafase		1
Chiavi a bussola 1/4" con bocca esagonale	4-4,5-5-5,5-6-7-8-9-10-11-12-13-14 mm	13	Forbice da elettricista		1
Prolunghe 1/2"	130-250 mm	2	Cutter multiuso		1
Prolunghe 1/4"	55-100 mm	2	Flessometro	3 m	1
Cricchetto reversibile 1/2"		1	Mini seghetto		1
Cricchetto reversibile 1/4"		1	Martello da meccanico	300 g	1
Impugnatura porta bussole 1/4"		1	Inseri ad intaglio	3-4-4,5-5-5,5-6-6,5-7-8	9
Snodo cardanico 1/2"		1	Inseri a croce PHILLIPS®	00-0-1(x2)-2(x2)-3-4	8
Snodo cardanico 1/4"		1	Inseri a croce POZIDRIV-SUPADRIV®	1-2(x2)-3-4	5
Bussola portainseri	1/4-1/4"	1	Inseri esagonali maschio	1,5-2-2,5-3-4-5-5,5-6-7-8 mm	10
Chiavi combinate	8-9-10-11-12-13-14-15-16-17-18-19 mm	12	Inseri esagonali maschio	1/16-5/64-3/32-7/64-1/8-9/64-5/32-3/16-7/32-1/4	10
Chiave a rullino	250 mm	1	Inseri TORX®	T8-T9-T10-T15-T20-T25-T27-T30-T40-T45	10
Giraviti ad intaglio	0,4x2,5x50-0,5x3x75-0,8x4x100-1x5,5x125-1,2x6,5x150-1,6x8x175	6	Inseri TORX® Tamper Resistant	T8-T10-T15-T20-T25-T27-T30-T35-T45	9
Giraviti a croce PHILLIPS®	1x75-2x125	2	Inseri Tri-Wing	1-2-3-4	4
Giraviti a croce POZIDRIV-SUPADRIV®	1x75-2x125	2	Inseri Spanner	4-6-8-10-12	5
Chiavi maschio esagonali	1,5-2-2,5-3-4-5-6-8-10 mm	9	Inseri Torq-set	6-8-10	3
Pinza universale	180 mm	1	Inseri quadrati	0-1-2(x2)-3	5
Pinza regolabile	250 mm	1	Inseri Clutch	1/8-5/32-3/16-1/4-5/16	5
Pinza a becchi mezzotondi	160 mm	1	Inseri per viti con impronta XZN	M5-M6-M8	3
Tronchese a taglio diagonale	160 mm	1	Inseri esagonali maschio con foro	2-2,5-3-4-5-6	6
			Inseri esagonali maschio con foro	5/64-3/32-7/64-1/8-9/64-5/32	6
			Prolunghe magnetiche	1/4"	2

002 JTMA

Cod. U00020015

Valigia trolley con assortimento per manutenzione

- Valigia con struttura in profilato di Alluminio.
- Doppia cerniera di chiusura in metallo con serratura.
- 3 pannelli portautensili interni con elastici di tenuta.
- Base con interno in mousse bicolore sagomata.

~~€ 619,50~~ | **€ 380,00**

181
PEZZI



**RUOTE INTEGRATE
NELLA STRUTTURA**

11 kg | 470 mm | 200 mm | 370 mm

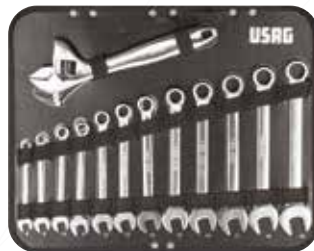

DESCRIZIONE	MISURA	PZ.
Chiavi a bussola 1/2" con bocca esagonale	10-11-12-13-14-15-16-17-18-19-21-22-24-27-30-32 mm	16
Chiavi a bussola 1/4" con bocca esagonale	4-4,5-5-5,5-6-7-8-9-10-11-12-13-14 mm	13
Prolunghe 1/2"	130-250 mm	2
Prolunghe 1/4"	55-100 mm	2
Cricchetto reversibile 1/2"		1
Cricchetto reversibile 1/4"		1
Impugnatura porta bussole 1/4"		1
Snodo cardanico 1/2"		1
Snodo cardanico 1/4"		1
Bussola portainseri	1/4-1/4"	1
Chiavi combinate	8-9-10-11-12-13-14-15-16-17-18-19 mm	12
Chiave a rullino	250 mm	1
Giraviti ad intaglio	0,4x2,5x50-0,5x3x75-0,8x4x100-1x5,5x125-1,2x6,5x150-1,6x8x175	6
Giraviti a croce PHILLIPS®	1x75-2x125	2
Giraviti a croce POZIDRIV-SUPADRIV®	1x75-2x125	2
Chiavi maschio esagonali	1,5-2-2,5-3-4-5-6-8-10 mm	9
Pinza universale	180 mm	1
Pinza regolabile	250 mm	1
Pinza a becchi mezzotondi	160 mm	1
Tronchese a taglio diagonale	160 mm	1
Giravite cercafase		1

DESCRIZIONE	MISURA	PZ.
Forbice da elettricista		1
Cutter multiuso		1
Flessometro	3 m	1
Mini seghetto		1
Martello da meccanico	300 g	1
Inseri ad intaglio	3-4-4,5-5-5,5-6-6,5-7-8	9
Inseri a croce PHILLIPS®	00-0-1(x2)-2(x2)-3-4	8
Inseri a croce POZIDRIV-SUPADRIV®	1-2(x2)-3-4	5
Inseri esagonali maschio	1,5-2-2,5-3-4-5-5,5-6-7-8 mm	10
Inseri esagonali maschio	1/16-5/64-3/32-7/64-1/8-9/64-5/32-3/16-7/32-1/4	10
Inseri TORX®	T8-T9-T10-T15-T20-T25-T27-T30-T40-T45	10
Inseri TORX® Tamper Resistant	T8-T10-T15-T20-T25-T27-T30-T35-T45	9
Inseri Tri-Wing	1-2-3-4	4
Inseri Spanner	4-6-8-10-12	5
Inseri Torq-set	6-8-10	3
Inseri quadrati	0-1-2(x2)-3	5
Inseri Clutch	1/8-5/32-3/16-1/4-5/16	5
Inseri per viti con impronta XZN	M5-M6-M8	3
Inseri esagonali maschio con foro	2-2,5-3-4-5-6	6
Inseri esagonali maschio con foro	5/64-3/32-7/64-1/8-9/64-5/32	6
Prolunghe magnetiche	1/4"	2

NEW

INSIEME UNICI

002 UDM

Cod. U00021706W

Valigia con assortimento per manutenzione

- Valigia con struttura in profilato di Alluminio.
- Doppia cerniera di chiusura in metallo con serratura.
- 3 pannelli portautensili interni con elastici di tenuta.
- Base con interno in mousse bicolore sagomata.

~~€ 797,00~~ | **€ 399,00**



		← 460
11 kg	mm	↓ 158
		↗ 385



74
UTENSILI



**CONTIENE LE PINZE SERIE AX,
I GIRAVITI 324
E LA CHIAVE A RULLINO 294 AD!**



**2 BATTERIE
INCLUSE**



12V XR

DCD706

Trapano avvitatore a percussione

- Coppia 57Nm.
- 0-425/1500 giri/minuto.
- Mandrino in metallo autoserrante 1-10mm.
- 2 batterie XR 12V 3.0AH.
- Caricabatterie rapido.



**MODELLO
CON PERCUSSIONE**



**BATTERIE
DA 3.0 AH**

INSIEME UNICI

NEW



002 UDE

Cod. U00022706W

Valigia con assortimento per elettricisti

- Valigia con struttura in profilato di Alluminio.
- Doppia cerniera di chiusura in metallo con serratura.
- 3 pannelli portautensili interni con elastici di tenuta.
- Base con interno in mousse bicolore sagomata.

€ 652,00 | **€ 399,00**



**CHIAVI COMBinate
NON INCLUDE**

**62
UTENSILI**



11 kg | 460 mm | 158 mm | 385 mm

**CONTIENE LE PINZE ISOLATE SERIE EX,
I GIRAVITI ISOLATI 091!**



**2 BATTERIE
INCLUSE**



12V XR

DCD706

Trapano avvitatore a percussione

- Coppia 57Nm.
- 0-425/1500 giri/minuto.
- Mandrino in metallo autoserrante 1-10mm.
- 2 batterie XR 12V 3.0AH.
- Caricabatterie rapido.



**MODELLO
CON PERCUSSIONE**



**BATTERIE
DA 3.0 AH**



Resistente agli urti



Resistente alle alte e basse temperature

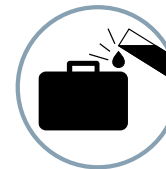

Anti corrosione



MAX
20 kg

4,7 kg
465 mm
352 mm
215 mm

001 RV

Cod. U00010004

Valigia porta utensili in polipropilene ad alto spessore (vuota)

- Due pannelli interni amovibili con elastici portautensili.
- Vano inferiore con divisori amovibili e regolabili.
- Doppia serratura con chiave.
- Maniglia ergonomica rivestita in gomma.
- 3 cerniere posteriori e doppio braccetto di tenuta coperchio in metallo.
- Gusci in polipropilene ad alto spessore montati su un'intelaiatura di alluminio.
- La struttura garantisce resistenza alle sostanze corrosive, alle basse ed alte temperature ed agli urti anche sugli angoli.

~~€ 253,00~~ | € 177,00



MAX
20 kg

6 kg
465 mm
352 mm
255 mm

001 TRV

Cod. U00010005

Valigia trolley porta utensili in polipropilene ad alto spessore (vuota)

- Maniglia telescopica in alluminio.
- Ruote con cuscinetto a sfera integrato.

~~€ 373,00~~ | € 261,00



641 T

Cassetta portautensili (vuota)

- In materiale plastico ad alta resistenza.
- 2 scomparti portaminuteria sul coperchio.
- Possibilità di chiusura con lucchetto (non fornito).
- Vassoio interno amovibile.

	CODICE	L (mm)	P (mm)	H (mm)	kg	
A	U06410004	16"	394	220	1,2 kg	€ 19,50 € 13,70
B	U06410005	19"	486	266	2,1 kg	€ 29,20 € 20,50
C	U06410006	24"	595	281	2,8 kg	€ 38,90 € 27,30



Sistema di apertura con una sola mano



Possibilità di chiusura con lucchetto (non fornito)



2 scomparti portaminuteria sul coperchio



532

Baule portautensili (vuoto)

- Apertura ad arresto a 95°.
- Gancio per chiusura a lucchetto.
- Struttura in lamiera di acciaio, spessore 1,2 mm.

	CODICE	L (mm)	P (mm)	H (mm)		
A	U05320005	520	290	290	6,8 kg	€ 113,00 € 79,50
B	U05320006	650	350	350	12,5 kg	€ 138,00 € 97,00
C	U05320007	850	350	350	16 kg	€ 140,00 € 98,00
D	U05320008	1000	400	450	19 kg	€ 181,00 € 127,00

5
SCOMPARTI



646/5V

Cod. U06460201

Cassetta estensibile (vuota)

- Predisposizione per lucchetto.
- Struttura in lamiera d'acciaio con verniciatura anaforetica.
- Dimensioni interne:
 - vano 447x207x100 mm.
 - scomparti 447x103x52 mm.

~~€ 54,00~~ | **€ 37,80**



5
SCOMPARTI



646/5LV

Cod. U06460301

Cassetta estensibile LUNGA (vuota)

- Predisposizione per lucchetto.
- Struttura in lamiera d'acciaio con verniciatura anaforetica.
- Versione lunga della cassetta 646/5V.
- Dimensioni interne:
 - vano 537x207x100 mm.
 - scomparti 537x103x52 mm.

~~€ 59,00~~ | **€ 41,30**

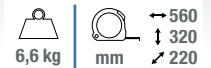

8
VASCHETTE

640 A

Cod. U06400001

Organizer (vuoto)

- Coperchio trasparente: visibilità istantanea del contenuto.
- 8 vaschette interne amovibili di cui 1 suddivisibile tramite 2 divisori in dotazione.
- Blocco delle vaschette interne tramite chiusura del coperchio.
- Clip esterne di chiusura in materiale plastico.

~~€ 26,10~~ | **€ 18,30**



Contenitori in tessuto



Cinghia posteriore per
fissare la borsa al trolley



8 pratici vani
e 6 elastici portautensili

007 FTSV

Cod. U00070060

Borsa portautensili pieghevole (vuota)

- Tessuto ad altissima resistenza.
- 8 pratici e comodi vani portautensili.
- Pannello centrale con elastici portautensili in entrambi i lati.
- Asole porta martello.
- Maniglia superiore con rivestimento in gomma.
- Cinghia posteriore per fissare la borsa al trolley.
- Possibilità di essere utilizzata con tracolla (non inclusa).
- Codice tracolla: U00070001Q.

~~€ 30,30~~ | **€ 21,30**



900 g | mm | → 340
↓ 235
↙ 90



Compatibile con

TSTAK™

STANLEY: FMST1-71968

DeWALT: DWST1-70705



MAX
12 kg

CAPACITÀ
30 L

3,1 kg | mm | → 355
↓ 225
↙ 460



Tasca porta Notebook
o documenti

007 SV

Cod. U00070004

Zaino professionale portautensili (vuoto)

- Nylon ad altissima resistenza.
- Cinturino pettorale regolabile.
- Cinghie in vita imbottite.
- Base rigida resistente all'acqua.
- Vano interno portautensili.
- Portadocumenti interno.
- La tasca posteriore può contenere Notebook di dimensioni: L 340 mm - H 240 mm.

~~€ 80,50~~ | **€ 56,50**



MAX
14 kg

CAPACITÀ
30 L

3,5 kg | mm | → 350
↓ 500
↙ 200



Tasca porta Notebook
o documenti

007 TV

Cod. U00070006

Trolley professionale portautensili (vuoto)

- Dimensioni bagaglio a mano (cabin size).
- Tessuto ad altissima resistenza.
- Pratici e comodi vani interni portautensili.
- Tasca frontale portadocumenti.
- Tasche laterali con cinghie per il trasporto di oggetti lunghi.
- Asta telescopica in alluminio.
- Ruote integrate nella struttura.
- Bretelle posteriori per il trasporto a spalla.
- La tasca posteriore può contenere Notebook di dimensioni L:340 mm - H:240 mm.

~~€ 100,00~~ | **€ 70,00**

YouTube



420 mm

MAX
11 kg

2,5 kg | 420 mm | 340 mm | 240 mm

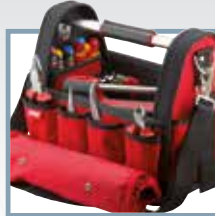

Tutta l'attrezzatura a portata di mano

007/1V

Cod. U00070001

Borsa professionale portautensili (vuota)

- Nylon ad altissima resistenza.
- Base rigida e resistente all'acqua.
- Pratici e comodi vani interni portautensili.
- Due tasche frontali portaminuteria.
- Pratico maniglione in alluminio.
- Ganci interni porta flessometro ed elastici portautensili.
- Mantella di chiusura tramite velcro.

~~€ 66,00~~ | **€ 46,20**



490 mm

MAX
15 kg

4 kg | 490 mm | 350 mm | 220 mm



Tasca frontale porta seghetto

007 V

Cod. U00070002

Borsa professionale portautensili (vuota)

- Nylon ad altissima resistenza.
- Base rigida resistente all'acqua.
- Vani interni portautensili e tasca frontale porta seghetto.
- Maniglione in alluminio con impugnatura rivestita.
- Cinghia di trasporto a tracolla.
- Mantella di chiusura con velcro.

~~€ 85,50~~ | **€ 60,00**



MAX
14 kg



1,8 kg | 460 mm | 160 mm | 350 mm



L'apertura frontale consente un rapido accesso al contenuto.

007 RV

Cod. U00070033

Borsa per utensili e PC (vuota)

- Tessuto ad altissima resistenza.
- Base rigida rinforzata.
- Può contenere Notebook di dimensioni L:340 mm - H:240 mm.
- 14 tasche, 2 cinghie portautensili e 1 gancio ferma flessometro.
- Tracolla amovibile per un comfort extra nel trasporto.
- Chiusura tramite fibbie a scatto con sgancio rapido.

~~€ 56,50~~ | **€ 39,60**

GIRAVITI 324 IL TOP DEL MERCATO



IMPUGNATURA TRIMATERIALE

- 1 Esterno in poliuretano resistente ad oli ed agenti chimici.
- 2 Corpo in poliammide resistente agli sforzi.
- 3 Interno in poliammide ad alta densità per un perfetto accoppiamento alla lama.

LAMA RINFORZATA

Acciaio al cromo silicio vanadio per la massima resistenza meccanica.



PUNTA AL TOP

Finitura zincata. Geometria perfetta. Trattamento anti corrosione.

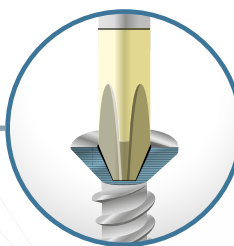

GEOMETRIA ANTI-ROTOLAMENTO

RIVESTIMENTO SOFT GRIP
Miglior comfort durante l'uso.
Maggior trasmissione della coppia.

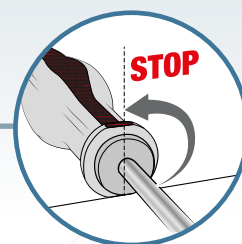

YouTube



8
PEZZI



324 SH8

Cod. U03240650

Serie di 8 giraviti per viti con intaglio e impronta a croce PHILLIPS®

- 324 D/0,4x2,5x50.
- 324/0,5x3x75-0,8x4x100-1x5,5x125-1,2x6,5x150.
- 324 PH/0x75-1x75-2x100.

~~€ 42,80~~ | **€ 27,50**



5
PEZZI



NEW

324 SH5

Cod. U03240645

Serie di 5 giraviti per viti con intaglio e impronta a croce PHILLIPS®

- 324/0,8x4x100-1x5,5x125.
- 324 PH/0x75-1x75-2x100.

~~€ 28,70~~ | **€ 18,90**



12
PEZZI



324 SH12

Cod. U03240651

Serie di 12 giraviti per viti con intaglio, impronta a croce PHILLIPS® e impronta a croce POZIDRIV® - SUPADRIV®

- 324 D/0,4x2,5x50.
- 324/0,5x3x75-0,8x4x100-1x5,5x125-1,2x6,5x150.
- 324 N/1x5,5x35.
- 324 PH/0x75-1x75-2x100.
- 324 NPH/2x35.
- 324 PZ/1x75-2x100.

~~€ 72,50~~ | € 49,00



7
PEZZI



324 STX/S7

Cod. U03240662

Serie di 7 giraviti con impronta TORX® Tamper Resistant

- 324 STX T10x75-T15x75-T20x100-T25x100-T27x100-T30x125-T40x150.

~~€ 84,00~~ | € 57,00



**Modello
con lama lunga**



324 LPH

Giraviti per viti con impronta a croce PHILLIPS®

- Modello con lama lunga.

CODICE	MISURA	L (mm)	€	€
U03240450	1x250	359	€ 9,65	€ 6,80
U03240451	2x250	370	€ 12,30	€ 8,70
U03240452	2x400	520	€ 14,90	€ 10,50

GIRAVITI 091 ISOLATI 1000 V

1000 V
EN 60900

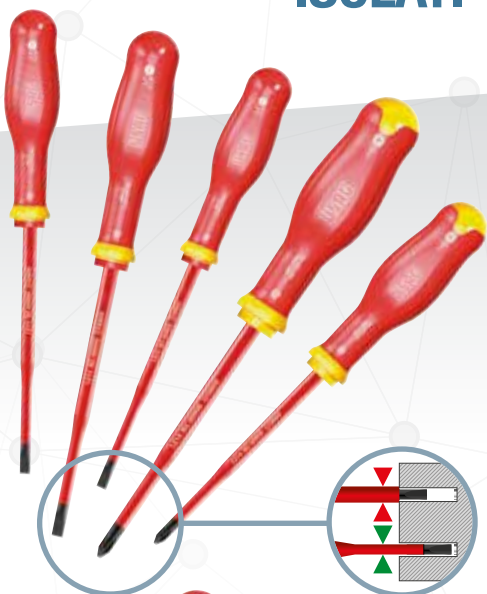

5

PEZZI



091 D/SH5

Cod. U00910119

Serie di 5 giraviti SLIM per viti con intaglio e per viti con impronta a croce PHILLIPS®

- 091 D/0,6x3,5x100-0,8x4x100-1x5,5x125.
- 091 DPH/1x100-2x125.

~~€ 48,50~~ | **€ 34,00**

USAG SLIM

GUAINA ISOLANTE

integrata nel diametro della lama

1000 V
EN 60900



5

PEZZI



091 SH5

Cod. U00910100

Serie di 5 giraviti per viti con intaglio e per viti con impronta a croce PHILLIPS®

- 091/0,5x3x75-0,8x4x100-1x5,5x125.
- 091 PH/1x100-2x125.

~~€ 39,90~~ | **€ 29,50**

1000 V
EN 60900



8

PEZZI



091 SH8

Cod. U00910106

Serie di 8 giraviti per viti con intaglio, per viti con impronta a croce PHILLIPS® e impronta a croce POZIDRIV® - SUPADRIV®

- 091/0,5x3x75-0,8x4x100-1x5,5x125-1,2x6,5x150.
- 091 PH/1x100-2x125.
- 091 PZ/1x100-2x125.

~~€ 68,50~~ | **€ 48,00**

GIRAVITI 322

QUALITÀ E CONVENIENZA



7

PEZZI



322 SH7

Cod. U03220254

Serie di 7 giraviti per viti con intaglio e impronta a croce PHILLIPS®

- 322//0,4x2x50-0,5x3x75-0,8x4x100-1,5,5x100-1,2x6,5x150.
- 322 PH/1x100-2x125.

~~€ 29,90~~ | **€ 21,00**



10

PEZZI



322 SH10

Cod. U03220255

Serie di 10 giraviti per viti con intaglio, impronta a croce PHILLIPS® e impronta a croce POZIDRIV®

- 322/0,4x2x50-0,5x3x75-0,8x4x100-1x5,5x100-1,2x6,5x150.
- 322 PH/0x75-1x100-2x125.
- 322 PZ/1x100-2x125

~~€ 44,50~~ | **€ 31,20**



7

PEZZI



322 STX/S7

Cod. U03220263

Serie di 7 giraviti con impronta TORX® Tamper Resistant

- 324 STX T10x75-T15x75-T20x100-T25x100-T27x100-T30x125-T40x150.

~~€ 51,50~~ | **€ 36,10**

GAMMA PINZE "AX": IL TOP DELLE PERFORMANCE FINITURA CROMATA ED IMPUGNATURE BIMATERIALE



Taglia fino a Ø 2 mm di filo armonico con il 30% in meno di forza rispetto al valore massimo indicato dalle normative europee ISO5749 (tronchesi) - ISO5746 (pinze).



TAGLIENTI TEMPRATI AD INDUZIONE
per la massima efficacia nel taglio del filo armonico.

FULCRO PIÙ VICINO AI TAGLIENTI
per il minimo sforzo durante il taglio.

IMPUGNATURE ERGONOMICHE BIMATERIALE

IMPUGNATURA USAG



- SFORZO

PRODOTTI SUL MERCATO



+ SFORZO

Minimo sforzo risultante dagli studi sugli sforzi muscolari effettuati dal prestigioso istituto americano US Ergonomics.



2 PEZZI

150 AX/SE2

Cod. U01500200

Assortimento con pinza universale e tronchese a tagliente diagonale

- Pinza universale 150 AX 180.
- Tronchese a grande effetto a tagliente diagonale 188 AX 160.

~~€ 54,50~~ | **€ 38,20**



3 PEZZI

150 AX/SE3

Cod. U01500201

Assortimento con pinza universale, pinza a becchi mezzotondi diritti e tronchese a tagliente diagonale

- Pinza universale 150 AX 180.
- Pinza a becchi mezzotondi lunghissimi diritti 133 AX 160.
- Tronchese a grande effetto a tagliente diagonale 188 AX 160.

~~€ 83,50~~ | **€ 58,50**

**CERNIERA
CHIUSA**



**2
PEZZI**

150 AX/SP2

Cod. U01500202

Assortimento con pinza universale e pinza regolabile

- Pinza universale 150 AX 180.
- Pinza regolabile a cerniera chiusa 180 C 250.

~~€ 57,00~~ | **€ 39,90**

Pinza multifunzione

PROFILI TONDI

Intaglio ricavato nella dentatura per una presa sicura di barre tonde, anche filettate.



PROFILI ESAGONALI

Geometria delle ganasce studiata per la presa di un esagono.

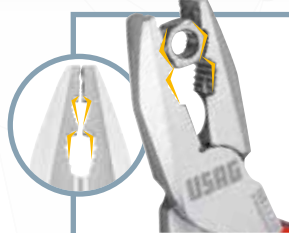

155 AX

Cod. U01550001

Pinza universale multifunzione

~~€ 51,50~~ | **€ 29,90**

**SISTEMA DI APERTURA
BREVETTATO**



MAX Ø
110
mm

135 B

Cod. U01350510

Pinza regolabile autobloccante a cremagliera con ganasce lunghe

- Ganasce forgiate.
- Dentatura studiata per una presa perfetta anche su tondo.
- Sistema di apertura brevettato ed integrato nei manici.
- Rullino di regolazione della presa integrato sul manico superiore.
- Cremagliera a 5 posizioni.

~~€ 65,00~~ | **€ 45,50**

**CERNIERA
SOVRAPPOSTA**



178 N

Pinza regolabile a cerniera sovrapposta

- Modello regolabile a 8 posizioni.
- Manici rivestiti con guaina in PVC.
- Esecuzione sabbata e verniciata.
- Corpo in acciaio.
- Dotata di arresto di sicurezza, protezione delle dita in ogni posizione di apertura.

CODICE	APERT. (mm)	L (mm)	PREZZO
U01780011	30	180	€ 18,40 € 12,90
U01780012	44	250	€ 23,00 € 16,10

PINZE ISOLATE 1000 V

**CERNIERA APERTA CON
ARTICOLAZIONE FORGIATA**

EN 60900



**TAGLIANTI TEMPRATI
AD INDUZIONE**

per la massima efficacia
nel taglio del filo dolce, di
media durezza e duro.

**IMPUGNATURE ERGONOMICHE
ISOLATE BIMATERIALE**



2

PEZZI



1000 V

085 EX/SE2

Cod. U00850120

Assortimento con pinza universale e
tronchese a tagliente diagonale isolati 1000 V

- 085 EX 180.
- 087 EX 160.

~~€ 73,50~~ | **€ 51,50**



3

PEZZI



1000 V

085 EX/SE3

Cod. U00850121

Assortimento con pinza universale, pinza
a becchi mezzotondi diritti e tronchese a
tagliente diagonale isolati 1000 V

- 081 EX 160.
- 085 EX 180.
- 087 EX 160.

~~€ 112,50~~ | **€ 79,00**

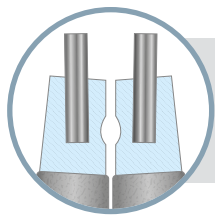

MASSIMA RESISTENZA

Punte in acciaio armonico inserite nei becchi.

4

PEZZI



4

PEZZI



127 N/SE4S

Cod. U01270046

Serie 4 pinze per anelli elastici

- Pinze per anelli elastici interni **127 N** 12÷25-**127 PN** 12÷25.
- Pinze per anelli elastici esterni **128 N** 10÷25-**128 PN** 10÷25.

~~€ 82,50~~ | **€ 58,00**

Misure
piccole

127 N/SE4

Cod. U01279000P

Serie 4 pinze per anelli elastici

- Pinze per anelli elastici interni **127 N** 19÷60-**127 PN** 19÷60.
- Pinze per anelli elastici esterni **128 N** 19÷60-**128 PN** 19÷60.

~~€ 89,50~~ | **€ 63,00**

Misure
grandi

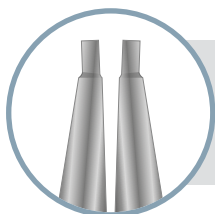

MASSIMA ACCESSIBILITÀ

Punte e becchi in corpo unico.

4

PEZZI



4

PEZZI



127 C/SE4S

Cod. U01270045

Serie 4 pinze per anelli elastici

- Pinze per anelli elastici interni **127 C** 12÷25-**127 CP** 12÷25.
- Pinze per anelli elastici esterni **128 C** 10÷25-**128 CP** 10÷25.

~~€ 69,00~~ | **€ 48,30**

Misure
piccole

127 C/SE4

Cod. U01270040

Serie 4 pinze per anelli elastici

- Pinze per anelli elastici interni **127 C** 19÷60-**127 CP** 19÷60.
- Pinze per anelli elastici esterni **128 C** 19÷60-**128 CP** 19÷60.

~~€ 75,00~~ | **€ 52,50**

Misure
grandi

SUPPORTI COMPATTI CON SISTEMA DI ESTRAZIONE RAPIDA



Estrazione della singola chiave senza muovere le altre.



I denti d'aggancio garantiscono la tenuta delle chiavi nel supporto.

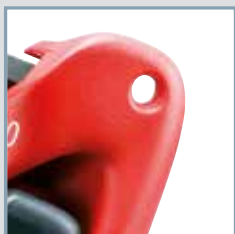

Il foro permette di appendere il supporto.



9 PEZZI



280 LTS/S9

Cod. U02800084

Serie di 9 chiavi maschio esagonale lunghe testa sferica

- 280 LTS/1,5-2-2,5-3-4-5-6-8-10 mm.

~~€ 29,30~~ | **€ 18,30**



8 PEZZI



280 LTSTX/S8

Cod. U02800078

Serie di 8 chiavi maschio lunghe testa sferica TORX®

- 280 LTSTX/T10-T15-T20-T25-T27-T30-T40-T45.

~~€ 53,00~~ | **€ 37,10**



9 PEZZI

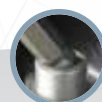

280 XLTS/S9

Cod. U02800184

Serie di 9 chiavi maschio esagonale extra-lunghe a testa sferica

- 280 XLTS/1,5-2-2,5-3-4-5-6-8-10 mm.

~~€ 32,40~~ | **€ 23,00**

Modello Extra lungo +30% rispetto alle 280 LTS

NUOVE CHIAVI MASCHIO CON IMPUGNATURA



SIGUREZZA GARANTITA

- +30% resistenza alla torsione rispetto alla norma ISO 2936.
- Raggiunta la coppia di rottura, la chiave si deforma senza spezzarsi.

NEW



IMPUGNATURA BIMATERIALE ERGONOMICA.

Stessa lama delle chiavi 280 T

ACCIAIO SPECIALE AL CROMO VANADIO.



6 PEZZI



280 HG/SE6

Cod. U02801460

Serie di 6 chiavi maschio esagonale con impugnatura

- 280 HG/2,5-3-4-5-6-8 mm.

~~€ 67,00~~ | **€ 48,00**

NEW

6 PEZZI



280 HGTS/SE6

Cod. U02801463

Serie di 6 chiavi maschio esagonale a testa sferica con impugnatura

- 280 HGTS/2,5-3-4-5-6-8 mm.

~~€ 74,00~~ | **€ 53,00**

NEW

6 PEZZI



280 HAP/SE6

Cod. U02800462

Serie di 6 chiavi maschio esagonale in pollici con impugnatura

- 280 HAP/1/4-7/32-5/32-5/16-3/8-3/16".

~~€ 67,50~~ | **€ 49,00**

6 PEZZI



280 HATX/SE6

Cod. U02800464

Serie di 6 chiavi maschio con impugnatura per viti con impronta TORX®

- 280 HATX/T8-T10-T15-T20-T25-T30.

~~€ 51,50~~ | **€ 38,00**

CHIAVE 280 T



YouTube



ACCIAIO SPECIALE
al cromo vanadio.



TRAVERSINO FISSO
Massima resistenza.



CHIAVI USAG **ALTRE CHIAVI**

SICUREZZA GARANTITA

- +30% resistenza alla torsione rispetto alla norma ISO 2936.
- Raggiunta la coppia di rottura, la chiave si deforma senza spezzarsi.

7
PEZZI



280 T/SE7

Cod. U02800903

Serie di 7 chiavi a T con maschio esagonale

- 280 T/2-2,5-3-4-5-6-8 mm.
- Per viti con esagono incassato.
- Acciaio speciale altamente legato al cromo vanadio.
- Esecuzione cromata con estremità brunate.

~~€ 103,00~~ | **€ 72,50**

8
PEZZI



280 TTX/SE8

Cod. U02800686

Serie di 8 chiavi a T per viti con impronta TORX®

- 280 TTX/T6-T7-T8-T9-T10-T15-T20-T25.
- Per viti con esagono incassato.
- Acciaio speciale altamente legato al cromo vanadio.
- Esecuzione cromata con estremità brunate.

~~€ 146,00~~ | **€ 102,00**



6
PEZZI



Testa
sferica

280 TTS/SE6

Cod. U02800760

Serie di 6 chiavi a T maschio esagonali con testa sferica

- 280 TTS/2,5-3-4-5-6-8 mm.
- Per viti con esagono incassato.
- Acciaio speciale altamente legato al cromo vanadio.
- Esecuzione cromata con estremità brunate.
- Modello che permette di operare con inclinazioni fino a 30° rispetto all'asse della vite.
- Massima accessibilità con la testa sferica.

~~€ 90,50~~ | € 63,50



4
PEZZI



Testa
sferica

280 TSTX/SE4

Cod. U02800790

Serie di 4 chiavi a T con impronta TORX® a testa sferica

- 280 TSTX/T15-T20-T25-T30.
- Acciaio speciale altamente legato al cromo vanadio.
- Esecuzione cromata con estremità brunate.
- Modello che permette di operare con inclinazioni fino a 30° rispetto all'asse della vite.
- Massima accessibilità con la testa sferica.

~~€ 75,50~~ | € 53,00



6
PEZZI



Traversino
scorrevole

280 TK/SE6

Cod. U02800020

Serie di 6 chiavi a T maschio esagonale con traversino scorrevole

- 280 TK/2,5-3-4-5-6-8 mm.
- Per viti con esagono incassato.
- Traversino scorrevole che permette di avere maggiore accessibilità rispetto alla chiave standard.
- Fermo di sicurezza che impedisce l'estrazione del traversino.
- Acciaio speciale altamente legato al cromo vanadio.
- Esecuzione cromata con estremità brunate per il gambo.
- Esecuzione interamente brunita per il traversino.
- Estremità dimensionate per il perfetto accoppiamento con la vite.

~~€ 93,50~~ | € 65,00



32
PEZZI

1/4



280 g | 138 mm
30 mm
98

692 J32

Cod. U06920042

Assortimento di inserti con cricchetto

DESCRIZIONE	MISURA	PZ.
Inserti ad intaglio	4-5,5-6,5-8	4
Inserti a croce PHILLIPS®	PH 1-2-3	3
Inserti a croce POZIDRIV®	PZ 1-2-3	3
Inserti esagono maschio	3-4-5-6	4
Inserti TORX®	T8-10-15-20-25-30-40	9
Inserti TORX® Tamper Resistant	STX 10-15-20-25-27-30-40	7
Portainseri magnetico		1
Cricchetto		1

~~€ 47,10~~ | **€ 32,50**



49
PEZZI

1/4



280 g | 138 mm
30 mm
98

692 J49

Cod. U06920041

Assortimento di inserti

DESCRIZIONE	MISURA	PZ.
Inserti ad intaglio	4-4,5-5,5-6,5-6,5-8	6
Inserti a croce PHILLIPS®	PH 1-1-2-2-2-3	6
Inserti a croce POZIDRIV®	PZ 1-1-2-2-2-3-3	7
Inserti esagono maschio	2-3-3-4-4-5-5-6-6	9
Inserti TORX®	TX 10-10-15-15-20-20-25-25-30-30	10
Inserti TORX® Tamper Resistant	STX 10-15-15-20-20-25-25-30-30-40	10
Portainseri magnetico		1

~~€ 36,40~~ | **€ 27,00**



100
PEZZI

1/4



900 g | 215 mm
45 mm
150

692 J100

Cod. U06920043

Assortimento di inserti con impronte speciali

DESCRIZIONE	MISURA	PZ.
Inserti a intaglio	3-4-4,5-5-5,5-6-6,5-7-8	9
Inserti a croce	PH 00-0-1-1-2-2-3-4 - PZ 1-2-2-3-4	13
Inserti esagono maschio	1,5-2-2,5-3-4-5-5,5-6-7-8 mm 1/16-5/64-3/32-7/64-1/8-9/64-5/32-3/16-7/32-1/4"	20
Inserti TORX®	T 8-9-10-15-20-25-27-30-40-45	10
Inserti TORX® Tamper Resistant	STX 8-10-15-20-25-27-30-35-40	9
Inserti Tri-Wing	1-2-3-4	4
Inserti Spanner	4-6-8-10-12	5
Inserti Torq-set	6-8-10	3
Inserti quadrati	0-1-2-2-3	5
Inserti Clutch	1/8-5/32-3/16-1/4-5/16	5
Inserti XZN	M5-M6-M8	3
Inserti esagono maschio con foro	2-2,5-3-4-5-6 mm - 5/64-3/32-7/64-1/8-9/64-5/32"	12
Portainseri magnetici	1/4x60mm	2

~~€ 56,00~~ | **€ 41,50**



Cricchetto



Giravite a T



Giravite corto



8

PEZZI



1/4



333 K/S8

Cod. U03330042

Assortimento COMBIDRIVE con inserti

DESCRIZIONE	MISURA	PZ.
Impugnatura Combidrive	333 K	1
Lama portainseri magnetica	333 1/4 MG	1
Inserti ad intaglio	660/0,6x4,5-1x5,5	2
Inserti a croce PH	660 PH 1-2	2
Inserti esagonali	660 E 3-4	2

~~€ 55,00~~ | **€ 38,50**



5,5-6-7-8
10-12-13 mm



7

PEZZI



1/4

664 B/S7

Cod. U06640015

Assortimento di inserti a bussola

- Fornito in cassetta di plastica

~~€ 31,40~~ | **€ 22,00**



664 S25

Cod. U06640111

Assortimento di inserti per avvitatura

- Fornito in cassetta di plastica

DESCRIZIONE	MISURA	PZ.
Inserti lunghi ad intaglio	3-4-5-6	4
Inserti lunghi a croce PH	1-2(x2)-3(x2)	5
Inserti lunghi a croce PZ	1-2(x2)-3(x2)	5
Inserti lunghi TORX®	T15-T20-T25-T30-T40	5
Inserti lunghi esagonali	2-3-4-5-5,5	5
Portainseri magnetico		1

~~€ 58,50~~ | **€ 39,00**

Riconoscimento dell'inserto con codice colore per una scelta rapida

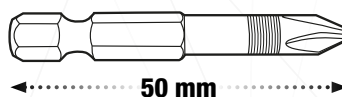

ESTRATTORI 458 E PER VITI ESAGONALI DANNEGGIATE



9
PEZZI



2-2,5-3-4-5-
6-7-8 mm



 Bussola
1/4 portainseri

458 E/B9
Cod. U04580313



Set di estrattori per viti esagonali danneggiate

- Profilo speciale esclusivo.
- Permettono di svitare viti esagonali anche molto danneggiate.
- In acciaio speciale con finitura fosfatata.
- Attacco esagonale da 1/4".
- Inclusa bussola portainseri 1/4-1/4".
- Fornito in astuccio di tessuto compatto.

DESCRIZIONE	ART./MISURA	PZ.
Estrattori per viti esagonali danneggiate 458 E 2-2,5-3-4-5-6-7-8		8
Bussola portainseri	684 1/4	1

~~€ 43,10~~ | **€ 29,90**

EFFICACE ANCHE SU VITI MOLTO DANNEGGIATE

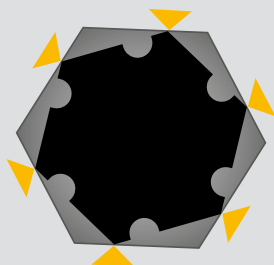

PROFILO ESCLUSIVO

Lo speciale design con cui sono realizzati gli inserti, permette di fare presa sugli esagoni incassati in qualunque condizione: intatti o completamente danneggiati.

VITI DANNEGGIATE

Quando una vite con esagono incassato si danneggia, non è più possibile svitarla con normali chiavi maschio esagonali. I nuovi estrattori 458 E permettono di svitare anche viti danneggiate fino al 98% del profilo esagonale.



1/4



 YouTube



20
PEZZI

← 210
↓ 60
mm ↗ 130

458 S20

Cod. U04580312

Assortimento di estrattori per viti e dadi esagonali danneggiati

- Composto da estrattori per profili esagonali esterni o incassati.
- Permettono di svitare viti e dadi esagonali anche molto danneggiati.
- In acciaio speciale con finitura fosfatata.
- 458 B: bussole con attacco 3/8 o 1/2" e profilo elicoidale conico.
- 458 E: inserti con attacco 1/4" e profilo speciale esclusivo.
- Inclusa bussola portainseri 1/4-1/4".
- Cassetta in ABS ad alta resistenza.
- Modulo interno in spugna bicolore.

DESCRIZIONE	ART./MISURA	PZ.
Estrattori per viti e dadi esagonali danneggiati	458 B 8-10-11-12-13-14-15-16-17-18-19	11
Estrattori per viti esagonali danneggiati	458 E 2-2,5-3-4-5-6-7-8	8
Bussola portainseri	684 1/4	1

~~€ 179,00~~ | **€ 120,00**

KIT COMPLETO PER VITI E DADI DANNEGGIATI



PROFILO ESCLUSIVO PER ESAGONI INCASSATI

Lo speciale design degli inserti permette di fare presa su esagoni incassati intatti o completamente danneggiati.

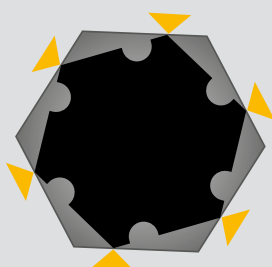

**2-2,5-3-4-5-
6-7-8 mm**



PROFILO ELICOIDALE PER DADI E VITI ESAGONALI

Le bussole elicoidali coniche garantiscono una presa esterna efficace su esagoni danneggiati.

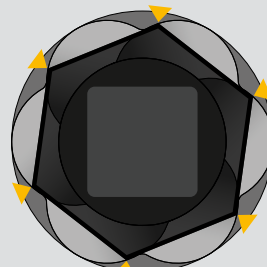

**8-10-11-12-13-
14-15-16-17-
18-19 mm**

454

Estrattori a due bracci per esterni

- Modello a bracci scorrevoli.
- Trave con esagono di supporto al serraggio.
- Bracci con unghiate ridotte.
- Vite in acciaio al carbonio.
- Corpo in acciaio al cromo vanadio.
- Esecuzione cromata e brunita.

CODICE	A	B	POTENZA	ESAGONO	PREZZO	PREZZO
U04540000	65 mm	70 mm	1,5 t	13 mm	€ 71,00	€ 49,70
U04540010	90 mm	110 mm	3 t	17 mm	€ 80,00	€ 56,00
U04540020	130 mm	110 mm	3 t	17 mm	€ 86,00	€ 60,50
U04540030	175 mm	165 mm	4 t	17 mm	€ 139,00	€ 97,50
U04540040	220 mm	165 mm	4 t	17 mm	€ 154,00	€ 108,00
U04540050	270 mm	220 mm	5 t	21 mm	€ 215,00	€ 151,00
U04540060	340 mm	220 mm	5 t	21 mm	€ 241,00	€ 169,00



4
PEZZI

COMPRESSE
NEL PREZZO

451 N/S4

Cod. U04510100

Estrattore a tre bracci per esterni

- Modello a bracci autoserranti.
- Capacità: 7÷140 mm.
- Potenza: 3 ton.
- Spina di sicurezza.
- Vite di manovra con esagono da 18 mm.
- Possibilità di utilizzo a due bracci.
- Viti di manovra M16x2.

€ 295,00 | € 149,00

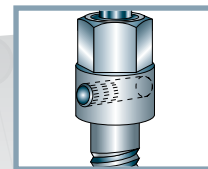

Spina di sicurezza:
utilizzo sicuro e qualità
dell'attrezzo preservata

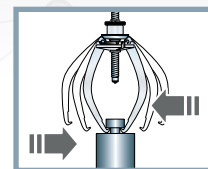

Autoserrante
Autocentrante

ESTRATTORI PER PRIGIONIERI E VITI SPEZZATE

Ø 6÷14
mm

25
PEZZI



460 A

Cod. U04600080

Serie di estrattori per prigionieri

- Fornita in cassetta in materiale plastico.

€ 142,00 | € 99,00

Ø 1÷6
mm

6
PEZZI



458 S6

Cod. U04580012

Serie di 6 estrattori conici

- Per la rimozione di viti o prigionieri spezzati che non offrono possibilità di presa.

€ 23,80 | € 16,70

**APERTURA
MAGGIORATA +20%**



YouTube

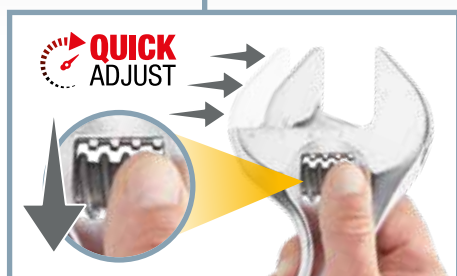

**ARRETRI IL RULLINO,
REGOLI RAPIDAMENTE.**

**RUOTI IL RULLINO,
REGOLI CON PRECISIONE.**

294 AD

Chiavi a rullino con regolazione rapida

- Si regola rapidamente arretrando il rullino.
- Grande capacità: apertura +20% rispetto allo standard.
- Doppia scala graduata: millimetri e pollici.
- Testa inclinata di 22°.
- Rullino in acciaio.
- Asola di aggancio.
- Finitura cromata.

CODICE	L	APERTURA	
U02940011	110 mm - 4"	17 mm	€ 16,70 € 11,70
U02940012	150 mm - 6"	23 mm	€ 17,50 € 12,30
U02940013	200 mm - 8"	33 mm	€ 20,90 € 14,70
U02940014	250 mm - 10"	38 mm	€ 26,60 € 18,70
U02940015	300 mm - 12"	41 mm	€ 34,90 € 24,50
U02940016	380 mm - 15"	50 mm	€ 64,00 € 44,80
U02940017	460 mm - 18"	63 mm	€ 105,00 € 73,50

**APERTURA
MAGGIORATA +20%**



YouTube



**POSIZIONE
STANDARD**

**GANASCIA
INVERTITA**

INVERTI

LA GANASCIA MOBILE
per passare dalla presa su
esagono a quella su tondo.

294 AG

Chiavi a rullino reversibili con impugnatura

- Nella posizione standard può manovrare un profilo esagonale.
- Invertendo il dente mobile, può manovrare un profilo tondo.
- Grande capacità: apertura +20% rispetto allo standard.
- Doppia scala graduata: millimetri e pollici.
- Impugnatura ergonomica bimatereale.
- Testa inclinata di 22°.
- Rullino in acciaio.
- Asola di aggancio.
- Finitura cromata.

CODICE	L	APERTURA	
U02940023	200 mm - 8"	33 mm	€ 22,90 € 16,10
U02940024	250 mm - 10"	38 mm	€ 29,20 € 20,50
U02940025	300 mm - 12"	41 mm	€ 38,40 € 26,90

**APERTURA
MAX 34 mm**

Solo 150 mm

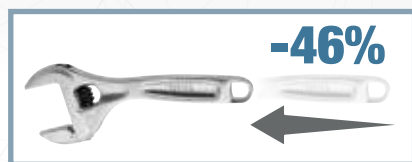

**LUNGHEZZA RIDOTTA
DEL 46% RISPETTO AD
UNA CHIAVE STANDARD**

294 AC

Cod. U02940010

Chiave regolabile a rullino corta

- Lunghezza ridotta del 46% rispetto ad una chiave standard.
- Apertura ganasce pari ad una chiave a rullino da 12".
- Leggera e compatta per un'ottima accessibilità.
- Regolazione tramite rullino in acciaio.
- Scala millimetrata sulla testa della chiave.
- Finitura cromata.

~~€ 20,80~~ | **€ 14,60**

285 CHIAVE COMBINATA



YouTube

FORCHETTA INCLINATA

Angolo di 15° rispetto all'asse della chiave.



SEZIONE A DOPPIA T

Massima resistenza alla flessione.

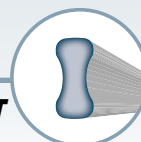

OCCHIO DISASSATO

Per dadi e bulloni incassati in posizioni di difficile accesso.

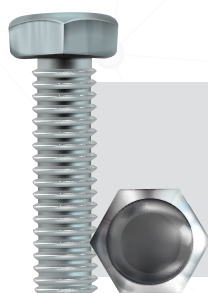

TOP PERFORMANCE

Resistenza alla torsione statica di anello e forchetta: **+50% rispetto alla norma ISO 1711-1.**

ISO 1711-1
SAE AS 954E



8
PEZZI

8÷19 mm

285 DS8

Cod. U02850863

Serie di 8 chiavi combinate

- 285/8-10-11-12-13-14-17-19 mm.
- Fornita con supporto in plastica.

~~€ 69,50~~ | € 45,00



26
PEZZI

6÷32 mm

285 SE26

Cod. U02850861

Serie di 26 chiavi combinate

- 285/6-7-8-9-10-11-12-13-14-15-16-17-18-19-20-21-22-23-24-25-26-27-28-29-30-32 mm.

~~€ 309,00~~ | € 211,00

285 KA

CHIAVE COMBINATA A CRICCHETTO CON ANELLO DI TENUTA

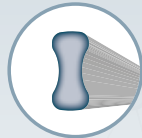

SEZIONE A DOPPIA T

Massima resistenza
alla flessione.

POSIZIONE OTTIMALE



ANELLO IN ACCIAIO ARMONICO INTEGRATO NELL'OCCHIO POLIGONALE

Mantiene la posizione sul dado
durante la manovra.



FORCHETTA CON SISTEMA ANTISLITTAMENTO DEL DADO

Maggiore tenuta durante la manovra.

CRICCHETTO RESISTENTE

Resistenza alla torsione statica del cricchetto:
+50% rispetto alla norma ISO 1711-1.



YouTube

8

PEZZI



8÷19 mm



12

PEZZI



7÷19 mm



285 KA/DS8

Cod. U02856058

Serie di 8 chiavi combinate a cricchetto
con anello di tenuta

- 285 KA/8-10-11-12-13-14-17-19 mm.

~~€ 139,50~~ | **€ 93,00**

285 KA/DS12

Cod. U02856062

Serie di 12 chiavi combinate a cricchetto
con anello di tenuta

- 285 KA/7-8-10-11-12-13-14-15-16-17-18-19 mm.

~~€ 211,00~~ | **€ 149,00**

8 PEZZI

6÷22 mm

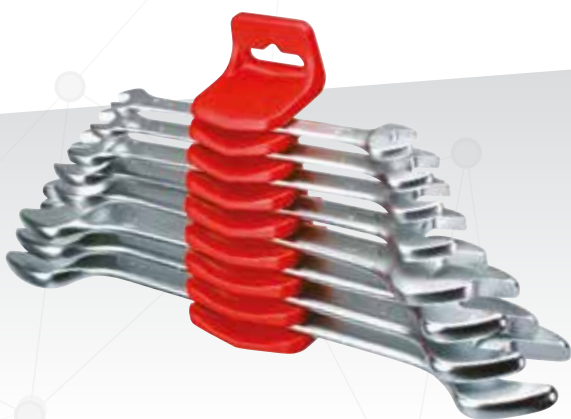

252 N/SR8

Cod. U02520862

Serie di 8 chiavi a forchetta doppie

- 252 N/6x7-8x9-10x11-12x13-14x15-16x17-18x19-20x22 mm.

~~€ 52,00~~ | **€ 36,40**

9 PEZZI

6÷23 mm



283 SE9

Cod. U02831405

Serie di 9 chiavi poligonali doppie curvate

- 283/6x7-8x9-10x11-12x13-14x15-16x17-18x19-20x22-21x23 mm.

~~€ 100,50~~ | **€ 59,00**

8 PEZZI

8÷19 mm



TESTA SNODATA



285 KF/DS8

Cod. U02856158

Serie di 8 chiavi combinate a cricchetto snodate

- 285 KF/8-10-11-12-13-14-17-19 mm.

~~€ 163,50~~ | **€ 115,00**

8 PEZZI

8÷19 mm



CAMBIO DEL SENSO DI ROTAZIONE



285 KB/SR8

Cod. U02856339

Serie di 8 chiavi combinate a cricchetto piatte

- 285 KB/8-10-12-13-14-15-17-19 mm.

~~€ 108,00~~ | **€ 76,00**

4

PEZZI



7÷13 mm



298 SN/SE4

Cod. U02980288

Serie di 4 chiavi flessibili a bussola esagonale con impugnatura

- 298 SN/7-8-10-13 mm.

~~€ 100,00~~ | € 70,00



Torsione massima
10 Nm

4

PEZZI



7÷13 mm



299 SE4

Cod. U02990200

Serie di 4 chiavi a bussola esagonale con impugnatura

- 299/7-8-10-13 mm.

~~€ 61,00~~ | € 42,70

8

PEZZI



7÷19 mm



276 CE/SE8

Cod. U02760484

Serie di 8 chiavi a T snodate

- 276 CE/7-8-10-12-13-14-17-19 mm.

~~€ 240,50~~ | € 168,00

LO SNODO CARDANICO USAG

- Molla di frizione interna per il perfetto preposizionamento della bussola.
- Bussola e cardano fissati con un perno in acciaio ribadito per la massima affidabilità.
- Chiavi progettate e prodotte rispettando la normativa UNI 6743.



237 A

CRICCHETTO REVERSIBILE CON MECCANISMO SIGILLATO IP51



Sistema di inversione integrato nel coperchio



Spessore della testa ridotto rispetto ai modelli standard



IMPUGNATURA CONICA in bimateriale e antiscivolo.

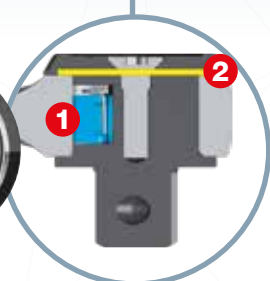

1. Nottolino brevettato.
2. Diaframma protettivo.

TOP PERFORMANCE

1. Resistenza alla torsione statica: +30% di coppia rispetto alla norma ISO 3315 grazie al nottolino brevettato.
2. Resistenza a fatica: dura il doppio dei normali cricchetti del mercato grazie alla protezione IP51.



23
PEZZI

1 1/2"

606 1/2" EA
Cod. U06060302



Assortimento in cassetta di ABS con bussole esagonali
• Cassetta in ABS ad alta resistenza con sistema di chiusura rapida.

DESCRIZIONE	ART./MISURA	PZ.
Chiavi a bussola con bocca esagonale	235 1/2 EN 8-9-10-11-12-13-14-15-16-17-18-19-21-22-23-24-27-30-32	19
Prolunghe	236 1/2 125-250	2
Snodo cardanico	241 1/2	1
Cricchetto reversibile certificato IP51	237 A 1/2	1



19
PEZZI

1 1/4"

606 1/4" EA
Cod. U06060101



Assortimento in cassetta di ABS con bussole esagonali
• Cassetta in ABS ad alta resistenza con sistema di chiusura rapida.

DESCRIZIONE	ART./MISURA	PZ.
Chiavi a bussola con bocca esagonale	235 1/4 EN 4-4.5-5-5.5-6-7-8-9-10-11-12-13-14	13
Prolunghe	236 1/4 50-100	2
Snodo cardanico	241 1/4	1
Leva a T con attacco quadro scorrevole	240 1/4	1
Portabussole con impugnatura	243 1/4	1
Cricchetto reversibile certificato IP51	237 A 1/4	1

~~€ 114,00~~ | **€ 70,00**

~~€ 216,00~~ | **€ 130,00**

BUSSOLE IN MILLIMETRI E POLLICI



35
PEZZI

1
2



612 1/2" MPA

Cod. U06122014



Assortimento in cassetta di lamiera con bussole poligonali

DESCRIZIONE	ART./MISURA	PZ.
Chiavi a bussola con bocca poligonale	235 1/2 N 10-11-12-13-14-15-16-17-18-19-22-24-27-30-32	15
Chiavi a bussola in pollici con bocca poligonale	235 1/2 PN 3/8-7/16-1/2-9/16-5/8-11/16-3/4-13/16-7/8-15/16-1-1 1/16-1 1/8-1 3/16-1 1/4	15
Prolunghe	236 1/2 125-250	2
Snodo cardanico	241 1/2	1
Leva a T scorrevole	240 1/2 N	1
Cricchetto reversibile certificato IP51	237 A 1/2	1

~~€ 375,00~~ | **€ 263,00**



17
PEZZI

3
4



612 3/4" EB

Cod. U06120017

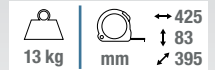

Assortimento in cassetta di lamiera con bussole esagonali

DESCRIZIONE	ART./MISURA	PZ.
Chiavi a bussola con bocca esagonale	235 3/4 N 22-23-24-26-27-28-30-32-36-38-41-46-50	13
Prolunghe	236 3/4 200-400	2
Leva a T scorrevole	240 3/4 N	1
Cricchetto reversibile con meccanismo sigillato 120 denti	237 B 3/4	1

~~€ 502,50~~ | **€ 352,00**

612 3/4" B

Cod. U06120016



BUSSOLE POLIGONALI

Assortimento in cassetta di lamiera con bussole poligonali

~~€ 502,50~~ | **€ 352,00**



12
PEZZI

1

612 1" ESI

Cod. U06120019

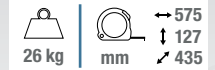

Assortimento in cassetta di lamiera con bussole esagonali

DESCRIZIONE	ART./MISURA	PZ.
Chiavi a bussola con bocca esagonale	235 1 EN 46-50-55-60-65-70-75-80	8
Prolunghe	236 1 200-415	2
Leva a T scorrevole	240 1 N	1
Cricchetto reversibile	237 1 SI	1

~~€ 873,50~~ | **€ 611,00**

IL TOP PER GLI SPAZI RISTRETTI



**50
PEZZI**

**1
4"**



608 1/4" EAK

Cod. U06080305



Assortimento in cassetta di ABS con prolunghe, cricchetto e bussole esagonali

- Cassetta in ABS ad alta resistenza con sistema di chiusura rapida.

DESCRIZIONE	ART./MISURA	PZ.
Chiavi a bussola con bocca esagonale	235 1/4 EN 4-4,5-5-5,5-6-7-8-9-10-11-12-13-14	13
Cricchetto con impugnatura rotante	237 1/4 AK	1
Portabussole con impugnatura	243 1/4	1
Portabussole flessibile con impugnatura	243 1/4 SN	1
Chiave a T con attacco quadro snodato	273 1/4 Q	1
Assortimento inserti con cricchetto reversibile - mini kit	606 1/4 SK	31
Raccordo aumentatore	247 1/4	1
Bussole portainseri	684/1	1

~~€ 230,35~~ | **€ 159,00**

NEW



**CHIAVE A T
SNODATA**



**IMPUGNATURA CON
LAMA FLESSIBILE**



**CRICCHETTO CON
IMPUGNATURA ROTANTE**



**CRICCHETTO PORTA
INSERTI SNODATO**

CRICCHETTI CON IMPUGNATURA ROTANTE

**1
4"**



237 1/4" AK

Cod. U02370003

Cricchetto reversibile 1/4" con impugnatura rotante

~~€ 45,60~~ | **€ 32,00**

**1
2"**



237 1/2" AK

Cod. U02370009

Cricchetto reversibile 1/2" con impugnatura rotante

~~€ 74,50~~ | **€ 52,50**



38
PEZZI

1/4"



900 g | 155 mm
50 mm
95

609 1/4" EB

Cod. U06090002



Assortimento con bussole esagonali ed inserti per avvitatura

- Cassetta compatta in bimatrimiale con rivestimento soft-touch.

DESCRIZIONE	ART./MISURA	PZ.
Bussole esagonali	235 1/4" EN 5,5-6-7-8-9-10-11-12-13-14 mm	10
Prolungha	236 1/4" 50-100	2
Cricchetto reversibile	237 B 1/4"	1
Snodo cardanico	241 1/4"	1
Impugnatura porta-bussole	243 1/4"	1
Inserti ad intaglio	660 0,6x4,5-1x5,5-1,2x6,5	3
Inserti PH	660 PH 1-2-3	3
Inserti PZ	660 PZ 1-2-3	3
Inserti esagonali	660 E 2-3-4-5-6	5
Inserti TORX® Tamper Resistant	660 STX T10-T15-T20-T25-T27-T30-T40	7
Inserto porta-bussole	660 Q 1/4"	1
Bussole porta-inserti	684 1/4"-1/4"	1



YouTube

€ 181,00 | € 127,00



Inserto portabussole



31
PEZZI

1/4"



350 g | 120 mm
35 mm
65

606 1/4" SK

Cod. U06060012

YouTube



Assortimento inserti con cricchetto reversibile

DESCRIZIONE	ART./MISURA	PZ.
Cricchetto reversibile	237 1/4" SFK	1
Inserti ad intaglio	660 0,5x4-1x5,5	2
Inserti esagonali	660 E 1,5-2-2,5-3-4-5-6-7-8	9
Inserti a croce PHILLIPS®	660 PH 1-2-3	3
Inserti a croce POZIDRIV®- SUPADRIV®	660 PZ 1-2-3	3
Raccordo portainseriti	660 Q 1/4"	1
Inserti TORX® Tamper Resistant	660 STX T10-T15-T20-T25-T27-T30-T40	7
Inserti TORX®	660 TX T6-T7-T8-T9	4
Prolunga magnetica	672 1/4" MG 100	1

€ 62,50 | € 45,00



11 mm



11
PEZZI

1/4"

5,5-6-7-8-9-10-11-12-13-14 mm

265 g | 120 mm
35 mm
65

610 1/4" EFK

Cod. U06100001

YouTube



Assortimento bussole ribassate con cricchetto reversibile

€ 82,50 | € 55,00

BUSSOLE ESAGONALI RIBASSATE

Garantiscono il doppio dell'accessibilità rispetto all'utilizzo di un cricchetto standard.

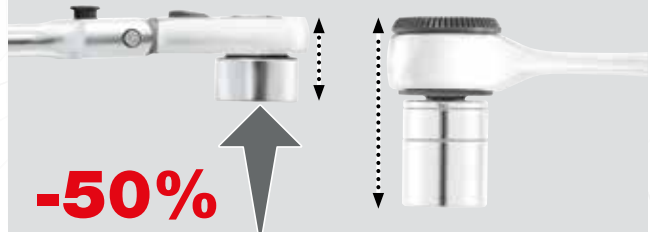

-50%



16
PEZZI

1 2"

1 4"



1 kg | mm | 190
58
144

601 1/4-1/2 JTX16

Cod. U06010009

Assortimento in cassetta modulare con bussole TORX®

DESCRIZIONE	MISURA	PZ.
Chiavi a bussola 1/4 TORX®	E6-E7-E8-E10	4
Chiavi a bussola 1/2 TORX®	E12-E14-E16-E18	4
Chiavi a bussola 1/4 con inserto TORX®	T10-T15-T20-T25	4
Chiavi a bussola 1/2 con inserto TORX®	T30-T40-T45-T50	4

~~€ 37,70~~ | **€ 26,50**



34
PEZZI

1 4"



1 kg | mm | 190
58
144

601 1/4 J34

Cod. U06010001

Assortimento in cassetta modulare con bussole esagonali ed inserti per avvitatura

DESCRIZIONE	MISURA	PZ.
Chiavi a bussola 1/4"	4-4,5-5-5,5-6-7-8-9-10-11-12-13-14	13
Cricchetto reversibile 1/4"		1
Snodo cardanico 1/4"		1
Prolunghe 1/4"	55-100	2
Inserti a intaglio	4-5,5-6	3
Inserti a croce POZIDRIV®	1-2-3	3
Inserti esagono maschio	4-5-6	3
Inserti TORX®	T10-T15-T20-T25-T30-T40	6
Impugnatura maschio/femmina		1
Raccordo portainseriti 1/4"		1

~~€ 61,00~~ | **€ 42,00**



22
PEZZI

1 2"



4 kg | mm | 375
80
186

601 1/2 J22

Cod. U06010003

Assortimento in cassetta modulare con bussole esagonali

DESCRIZIONE	MISURA	PZ.
Bussole esagonali 1/2"	8-10-11-12-13-14-15-16-17-18-19-21-22-24-27-30-32	17
Cricchetto 1/2"		1
Prolunghe 1/2"	130-250	2
Snodo cardanico 1/2"		1
Leva a T 1/2"		1

~~€ 106,00~~ | **€ 69,00**

LA QUALITÀ **USAG** A UN PREZZO *Just*

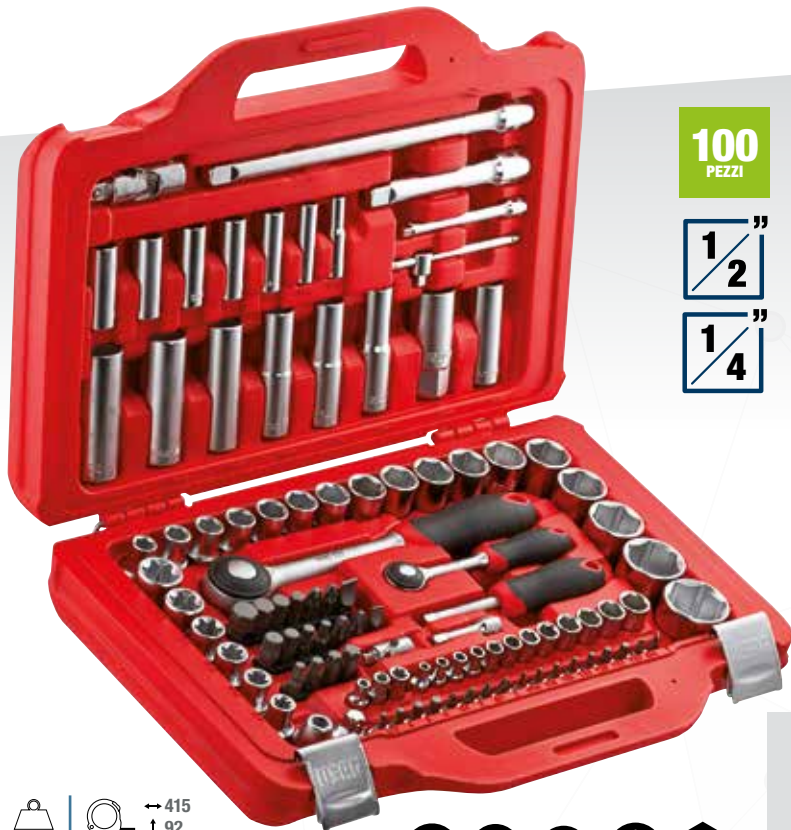

100
PEZZI

1/2"

1/4"

601 1/4-1/2 J100

Cod. U06010011



Assortimento in cassetta modulare con bussole esagonali ed inserti per avvitatura

€ 177,00 | **€ 116,00**



Modulare con i cassettei dei carrelli USAG!

8 kg | 415 mm | 92 | 283



82
PEZZI

1/2"

1/4"

601 1/4-1/2 J82

Cod. U06010010



Assortimento in cassetta modulare con bussole esagonali e chiavi combinate

€ 267,00 | **€ 170,00**



Modulare con i cassettei dei carrelli USAG!

7 kg | 415 mm | 92 | 283



ISO 6789

810 F

Chiave dinamometrica con cricchetto reversibile a testa snodata

- Testa snodata per agevolare l'utilizzo in spazi ridotti o profondi.
- Angolo di inclinazione fino a 20°.
- Scala di lettura in Nm.
- Modello a coppia regolabile per serraggi destrorsi.
- Riarmo automatico al rilascio dopo il disinnesto.
- Fornita con certificato di collaudo.

ARTICOLO	CODICE	CAPACITÀ	☑	L (mm)	RISOL.	
810 F 100	U08104013	20 ÷ 100	1/2"	447	0,25	€ 209,00 € 136,00
810 F 200	U08104015	40 ÷ 200	1/2"	500	0,5	€ 209,00 € 136,00

⚠ IMPORTANTE ⚠

Quando la chiave è utilizzata inclinata a +/- 20° la coppia di serraggio deve essere impostata con un incremento del +5%.
Esempio: Coppia necessaria 90 Nm = Coppia per uso inclinato 94,5 Nm.



YouTube

PRECISIONE
±4%

1/2"



ISO 6789

810 N

Chiave dinamometrica con cricchetto reversibile

- Modello a coppia regolabile per serraggi destrorsi.
- Riarmo automatico al rilascio dopo il disinnesto.
- Fornita con certificato di collaudo.

ARTICOLO	CODICE	CAPACITÀ	☑	L (mm)	RISOL.	
810 N 5	U08104000	1÷5	1/4"	197	0,05	€ 200,00 € 126,00
810 N 25	U08104001	5 ÷ 25	1/4"	290	0,05	€ 200,00 € 126,00
810 N 50	U08104002	10 ÷ 50	3/8"	350	0,25	€ 200,00 € 126,00
810 N 100	U08104003	20 ÷ 100	1/2"	410	0,25	€ 200,00 € 126,00
810 N 200	U08104005	40 ÷ 200	1/2"	475	0,5	€ 200,00 € 126,00
810 N 340	U08104006	68 ÷ 340	1/2"	630	1	€ 231,00 € 150,00

PRECISIONE
±4%

1/4"

3/8"

1/2"



ISO 6789

812 N

Chiavi dinamometriche con cricchetto reversibile

- **812 N 600:** Modello a coppia regolabile per serraggi destrorsi e sinistrorsi con rotazione del cricchetto di 180°.
- **812 N 1000:** Modello a coppia regolabile per serraggi destrorsi e sinistrorsi.
- Precisione ±4% del valore di coppia impostato.
- Scala di lettura in Nm.
- Segnale sensitivo e sonoro al raggiungimento della coppia impostata.
- Riarmo automatico al rilascio dopo il disinnesto.
- Blocco di sicurezza dopo la regolazione della coppia.
- Fornita in cassetta di lamiera completa di certificato di collaudo.
- Cricchetto con attacco quadro 3/4".

ARTICOLO	CODICE	CAPACITÀ	☑	
812 N 600	U08120006	120 ÷ 600	3/4"	€ 920,00 € 644,00
812 N 1000	U08120010	200 ÷ 1000	3/4"	€ 1.151,00 € 806,00

3/4"

PRECISIONE
±4%

Serraggi controllati utilizzando cricchetti o chiavi a T

1/2"



YouTube

814 A

Dispositivo digitale coppia-angolo

- Permette serraggi coppia ed angolo di precisione digitale anche con utensili tradizionali.
- Per serraggi destrorsi e sinistrorsi.
- Scala di lettura in Nm/ft.lb/in-lb/kg.cm/gradi.
- Doppia indicazione: luminosa (LED) e sonora (buzzer) al raggiungimento del valore impostato.
- 9 valori di coppia o angolo preimpostabili.
- 50 misurazioni memorizzabili.
- In custodia di ABS con certificato di taratura.
- Alimentazione: 2 batterie AAA (incluse).

CODICE	CAPACITÀ	█	RISOL.	
U08140003	6,8 - 135	1/2"	0,1	€ 230,00 € 161,00
U08140004	10 - 200	1/2"	0,1	€ 256,00 € 186,00
U08140005	17 - 340	1/2"	0,1	€ 321,00 € 225,00

Misurazione corretta dell'angolo in qualsiasi posizione

PRECISIONE
±2%



YouTube

831 A

Cod. U08310001

Goniometro digitale

- Permette serraggi angolari di precisione digitale in totale semplicità.
- Per serraggi destrorsi e sinistrorsi.
- Precisione angolo: +/- 2%.
- Scala: 0÷360°.
- Risoluzione: 0,1°.
- Doppia indicazione : luminosa (LED) e sonora (buzzer) al raggiungimento del valore impostato.
- 9 valori di angolo preimpostabili.
- 50 misurazioni memorizzabili.
- Fornito in custodia di ABS con certificato di taratura.
- Alimentazione: 2 batterie AAA (incluse nella confezione).

~~€ 167,00~~ | **€ 109,00**

Rapporto di moltiplicazione

1:3,4



Ingresso

Uscita

CAPACITÀ
1400
Nm

1/2"

3/4"

828 X4

Cod. U08280401

Moltiplicatore di coppia

- Modello compatto e leggero per interventi di manutenzione su veicoli industriali e macchine agricole.
- Fornito con leva di contrasto in custodia di nylon.
- Rapporto di trasmissione 4:1.
- Coppia max in ingresso: 400 Nm.

~~€ 759,00~~ | **€ 530,00**

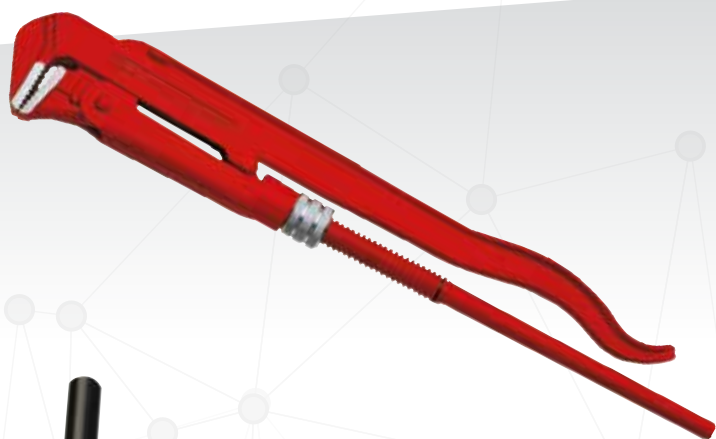

305 N

Giratubi modello svedese con ganasce a 90° diritte

- Acciaio al cromo vanadio.

CODICE	CAPACITÀ	LUNGHEZZA	
U03050002	1"	40 mm	330 mm € 34,50 € 24,30
U03050003	1 1/2"	55 mm	420 mm € 46,10 € 32,30
U03050004	2"	67 mm	540 mm € 71,00 € 49,70
U03050005	3"	103 mm	690 mm € 106,00 € 74,50



7
PEZZI



9÷17 mm

307 A/S7

Cod. U03070001

Chiave per sottolavelli

- Per il montaggio di rubinetti e miscelatori con fissaggio a dado.
- Braccio cavo di 25 cm di lunghezza.
- Estremità cava per dadi esagonali di 13 mm.
- Adattatori forniti: 9,10,11,12,14,17 mm.

~~€ 38,00~~ | **€ 26,60**



PLASTICA

Ø 35 mm Ø 1 3/8"

317 K

Cod. U03170012

Tagliatubi per tubi in plastica

- Per il taglio di tubi in PEX, PEHD, PVC, PER.
- Modello a cremagliera per un'azione di taglio progressiva con il minimo sforzo.
- Corpo in lega leggera.
- Esecuzione verniciata.

~~€ 49,40~~ | **€ 34,60**

Inserto in acciaio filettato per uno scorrimento rapido



Ø 3-30 mm Ø 1/8-1 1/8"

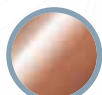

RAME

314 C

Cod. U03140032

Tagliatubi per tubi in rame e lega leggera

- Rulli di scorrimento scanalati per il taglio di tubi bordati.
- Sostituzione rapida della rotella senza bisogno di utensili.
- Spessore massimo tubo: 2 mm.

~~€ 32,00~~ | **€ 22,40**

207 E FORZA D'ACCIAIO



YouTube



L'UNICA CON STRUTTURA INTEGRALE IN ACCIAIO INOX
resiste alla flessione fino a 180 kg.

SPELLAFILI INTEGRATO



1. Spellatura.
2. Crimpatura.

TAGLIACAVI SU ENTRAMBE LE LAME



Adatto per cavi multipolari.

LAMA MICRODENTATA ANTISCIVOLO



207 E

Cod. U02070006

Forbice professionale per elettricisti

€ 34,90 | € 25,00



207 D

IL RIFERIMENTO PER GLI ELETTRICISTI



IMPUGNATURA RESISTENTE ALLA FLESSIONE FINO A 80 kg
in tecnopolimero caricato vetro.

ASOLE MAGGIORATE



207 D

Cod. U02070008

Forbice professionale per elettricisti

€ 22,90 | € 15,90



50 mm²

LAME FLUIDE E ROBUSTE

In acciaio inox con microdentatura e tagliacavi.



YouTube

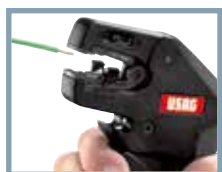

Ø 0,02÷10 mm²



146 B

Cod. U01460004

Pinza spellafili
automatica piegata a 90°

~~€ 104,00~~ | **€ 73,00**



Ø 4÷28 mm²



163

Cod. U01630001

Sguainacavi multifunzione

- Per il taglio circolare e longitudinale di cavi con rivestimento esterno in PVC.

~~€ 36,10~~ | **€ 25,30**



YouTube



0,5÷1 mm²
1,5÷2,5 mm²
4÷6 mm²

751

Cod. U07510002

Pinza per capicorda
preisolati

~~€ 53,50~~ | **€ 37,50**

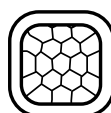

0,14÷10 mm²



Isolati



Non isolati



753 KA

Cod. U07530004

Crimpatrice autoregolante per
puntalini a sezione quadra

~~€ 210,00~~ | **€ 147,00**



9 PROFILI

Per armadi e
impianti tecnici



767

Cod. U07670001

Chiave a croce universale

~~€ 61,50~~ | **€ 43,10**

- 1-1,2-1,5-1,8-2-2,5-3 mm
- + PH0-PH00-PH000
- ☆ T5-T6-T7-T8-T9
- ⚙ TT10-TT15-TT20
- ⚙ PZ0-PZ1
- 0,9-1,3-1,5-2-2,5-3-4 mm
- + PT2-PT3-PT4
- PT0-PT1



341 SH33

Cod. U03410019

Giravite di precisione portainseri con 32 inserti

~~€ 35,10~~ | **€ 24,60**

SMART FUNCTION

Selezione automatica della
tensione AC/DC, resistenza
e frequenza

MAX
600 V

RMS



074 A

Cod. U00740001

Multimetro digitale compatto SMART

- Misurazione di AC/DC.
- Misurazioni di resistenza e continuità (suono acustico se resistenza circuito è inferiore 40 Ω).
- Misurazioni frequenza.
- Misurazione corrente AC/DC con pinza amperometrica 076 P.



CAT III 600V

CARATTERISTICHE TECNICHE

Tensione continua DC	1÷600 mV÷V
Tensione alternata AC	1÷600 mV÷V
Resistenza	0÷10 Ω -M Ω
Frequenza	3÷40 kHz
Tipo batterie (fornite)	2xAAA 1,5V

~~€ 128,00~~ | € 90,00

Ideale sui terminali
dell'inverter delle
auto ibride ed
elettriche (CEI 11-27)

MAX
690 V



076 G

Cod. U00760006

Tester di tensione

- Rilevamento tensione/continuità.
- Identificazione fase/neutro.
- Test rotazione di fase.
- Segnalazione visiva e acustica.



CARATTERISTICHE TECNICHE

Tensione continua/alternata DC/AC	12÷690 mV÷V
Frequenza	50÷60 kHz
Tipo batteria (fornite)	1x9V

~~€ 117,00~~ | € 82,00



007 MV

Cod. U00070035

Marsupio portautensili (vuoto)

- Tessuto ad altissima resistenza.
- Sistema di fissaggio alla cintura con chiusura in velcro.
- 4 tasche portautensili elasticizzate.
- Gancio porta nastro.

~~€ 17,70~~ | € 12,40



007 MLV

Cod. U00070030

Marsupio portautensili con cintura (vuoto)

- Tessuto ad altissima resistenza.
- 6 tasche portautensili elasticizzate.
- Gancio porta nastro.
- Cintura regolabile da 80 a 120 cm.

~~€ 35,40~~ | € 24,80

360°



TESTA ORIENTABILE



ALLUMINIO

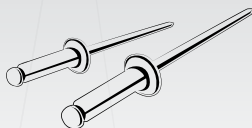

- Ø 2,4 mm
3/32"
- Ø 3,2 mm
1/8"
- Ø 4,0 mm
5/32"
- Ø 4,8 mm
3/16"

995 AF

Cod. U09950006

Rivettatrice con testa orientabile

- Testa orientabile liberamente a 360°.
- Adatta a rivetti in alluminio.
- 4 testine intercambiabili.
- Corpo in lega leggera.
- Manici in materiale plastico.
- Clip in metallo per blocco apertura.
- Chiave smontaggio testine in dotazione.

~~€ 30,30~~ | **€ 21,00**



Serbatoio porta steli

COMPATTA E POTENTE

Solo 330 mm di lunghezza
20% di sforzo in meno rispetto al modello standard.

995 LA

Cod. U09950004

Rivettatrice dritta compatta

- Modello compatto con la stessa capacità di una rivettatrice lunga standard.
- Il sistema di leve interno riduce lo sforzo dell'operatore.
- Adatta a rivetti in alluminio ed acciaio
- 5 testine intercambiabili.
- Serbatoio amovibile per recupero steli.
- Corpo in lega leggera.
- Manici in materiale plastico.

~~€ 53,50~~ | **€ 37,00**

**-20%
DI SFORZO**

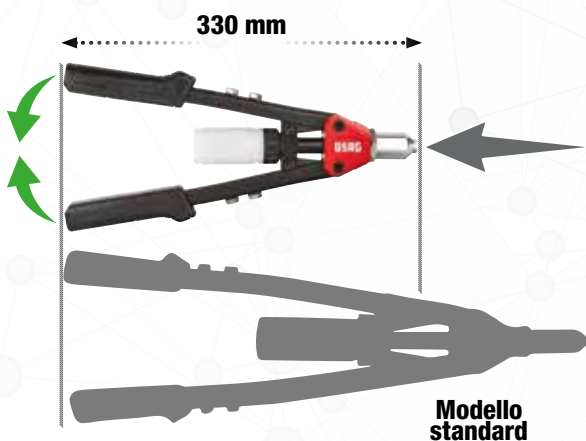

ALLUMINIO E ACCIAIO

- Ø 2,4 mm
3/32"
- Ø 3,2 mm
1/8"
- Ø 4,0 mm
5/32"
- Ø 4,8 mm
3/16"
- Ø 6,4 mm
1/4"



ALLUMINIO E ACCIAIO

- Ø 2,4 mm
3/32"
- Ø 3,2 mm
1/8"
- Ø 4,0 mm
5/32"
- Ø 4,8 mm
3/16"

**SOLO
ALLUMINIO**

995 A

Cod. U09950001

Rivettatrice

- Corpo in lega leggera.
- Leva di pressione in lamiera d'acciaio imbutita.
- Molla di richiamo per l'apertura dei manici.
- Fornita con 3 testine intercambiabili e chiave di servizio.

~~€ 28,20~~ | **€ 19,80**



ALLUMINIO E ACCIAIO

- Ø 2,4 mm
3/32"
- Ø 3,2 mm
1/8"
- Ø 4,0 mm
5/32"
- Ø 4,8 mm
3/16"

926 A

Cod. U09260001



Rivettatrice oleopneumatica

- Fornita con quattro testine intercambiabili e chiave di servizio.

CARATTERISTICHE TECNICHE

Corsa	14 mm
Consumo medio aria	113 l/min
Pressione aria raccomandata	6,2 bar
Vibrazioni	1,3 m/s ²
Attacco aria	1/4"
Diametro interno tubo aria	10 mm

~~€ 209,00~~ | **€ 146,00**

995 K

Cod. U09950005

Assortimento in cassetta di plastica

DESCRIZIONE	MISURA	PZ.
Rivettatrice	995 A	1
Rivetti in alluminio	995 AL/4,8x12	100
Rivetti in alluminio	995 AL/3x10	100
Rivetti in alluminio	995 AL/4x10	100
Rivetti in alluminio	995 AL/3x8	100
Rivetti in alluminio	995 AL/4x12	100

~~€ 80,50~~ | **€ 56,50**



**501
PEZZI**

2 kg | 435 mm | 70 | 270

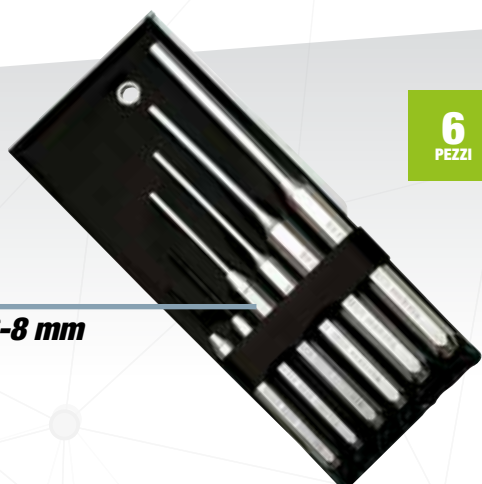

6
PEZZI

2-3-4-5-6-8 mm

367 SE6

Cod. U03670081

Serie di 6 cacciaspine

- 367/2x110-3x130-4x145-5x165-6x180-8x200 mm.
- Fornita in busta di plastica.
- Acciaio al cromo vanadio.
- Punte riportate e fosfatate per le misure da 2 e 3 mm.

~~€ 49,00~~ | **€ 34,30**



UNI 7777
DIN 6475

Testa in acciaio al carbonio forgiata e sottoposta a trattamento termico differenziato per garantire una maggiore durata ed evitare scheggiature o ricalcature della superficie battente.

382

Martelli per meccanici

- Modello tedesco a testa quadra piana e penna simmetrica.
- Manico in frassino.

CODICE	PESO TESTA	LUNGHEZZA	
U03820002	100 g	260 mm	€ 10,10 € 7,10
U03820004	200 g	280 mm	€ 10,50 € 7,40
U03820006	300 g	300 mm	€ 11,60 € 8,20
U03820007	400 g	310 mm	€ 13,80 € 9,70
U03820008	500 g	320 mm	€ 15,60 € 11,00
U03820009	600 g	330 mm	€ 17,90 € 12,60
U03820010	800 g	350 mm	€ 20,80 € 14,60
U03820011	1000 g	360 mm	€ 23,40 € 16,40
U03820013	1500 g	380 mm	€ 31,30 € 22,00
U03820014	2000 g	400 mm	€ 40,60 € 28,50



DIN 1041

MATERIALI COMBINATI PER UN RISULTATO OTTIMALE.

1. Anima in grafite: massima resistenza alla flessione.
2. Elevata qualità: corpo in polipropilene che assorbe le vibrazioni.
3. Rivestimento in gomma resistente agli idrocarburi.

382 F

Martelli per meccanici manico in graphite

- Modello tedesco a testa quadra piana e penna simmetrica.
- Manico in graphite.

CODICE	PESO TESTA	LUNGHEZZA	
U03820102	200 g	285 mm	€ 16,70 € 11,70
U03820103	300 g	300 mm	€ 17,90 € 12,60
U03820105	500 g	310 mm	€ 20,30 € 14,30
U03820107	800 g	350 mm	€ 25,10 € 17,60
U03820108	1000 g	355 mm	€ 27,20 € 19,10



6
PEZZI

372 SE6

Cod. U03720181

Assortimento in busta di plastica

- Acciaio al cromo vanadio.

DESCRIZIONE	MISURA	PZ.
Scalpelli	362/125-150	2
Ugnetto	364/125	1
Punzoni	366/3x125-4x150	2
Bulini	368/4x125	1

~~€ 50,50~~ | **€ 35,40**



UNI 7784

376

Mazzuole

- Modello a tasselli intercambiabili in materiale plastico.
- Corpo in acciaio al carbonio.
- Manico in frassino.

CODICE	Ø TASSELLI	LUNGHEZZA	
U03760001	22 mm	250 mm	€ 11,60 € 8,20
U03760002	28 mm	275 mm	€ 14,70 € 10,30
U03760003	35 mm	300 mm	€ 18,70 € 13,10
U03760004	42 mm	325 mm	€ 25,20 € 17,70
U03760005	50 mm	350 mm	€ 34,50 € 24,20
U03760006	60 mm	380 mm	€ 50,00 € 35,00

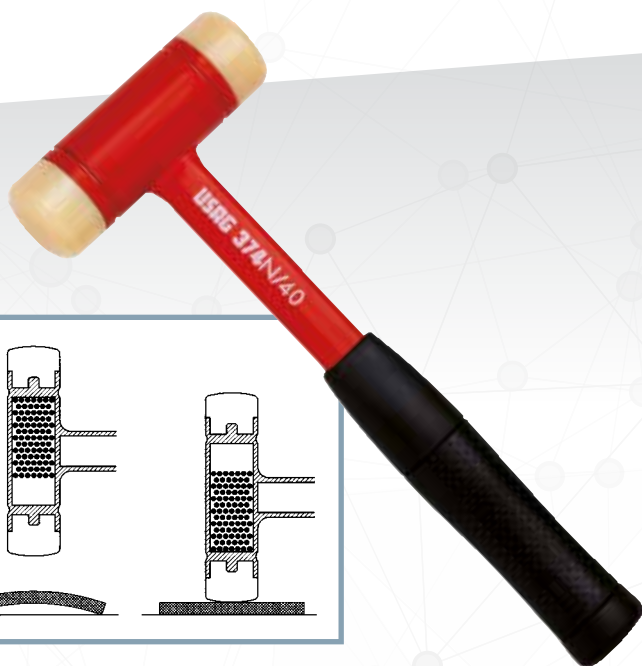

374 N

Mazzuole antirimbalzo

- Modello a tasselli intercambiabili in materiale plastico.
- Corpo in acciaio al carbonio.

CODICE	Ø TASSELLI	LUNGHEZZA	
U03740004	35 mm	310 mm	€ 37,10 € 26,00
U03740005	40 mm	315 mm	€ 41,70 € 29,20
U03740006	50 mm	325 mm	€ 50,00 € 35,00
U03740007	50 mm	335 mm	€ 58,50 € 41,00

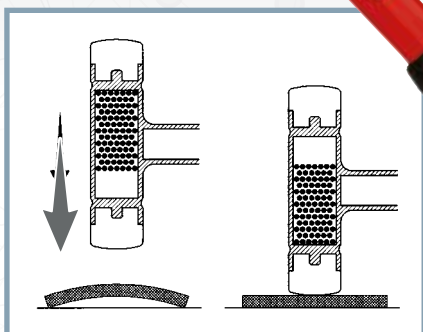

Testa parzialmente riempita con graniglia metallica per l'assorbimento del rimbalzo



Adatta per movimentazione lastre di vetro, marmo e lamiere metalliche



MAX
25 kg

424 A2

Cod. U04240102

Ventosa manuale multiuso

~~€ 20,90~~ | **€ 14,70**

Adatta per movimentazione lastre di vetro, marmo e lamiere metalliche



MAX
130 kg



424 A3

Cod. U04240103

Ventosa multiuso con impugnatura in acciaio e pompa manuale

~~€ 239,00~~ | **€ 167,00**

Fornita in valigetta



424 N4

Cod. U04240008

Ventosa per trasporto/posizionamento cristalli

~~€ 40,30~~ | **€ 28,30**



MAX
80 kg

Lama intercambiabile



424 C2

Cod. U04240112

Raschietto per rimozione adesivi e collanti

~~€ 12,40~~ | **€ 8,70**



3
PEZZI



987 E/S3

Cod. U09870050

Serie di 3 spatole

• 987 E 32-50-75.

~~€ 27,50~~ | **€ 19,30**

Lame flessibili

3
PEZZI



987 F/S3

Cod. U09870051

Serie di 3 spatole

• 987 F 32-32 P-50.

~~€ 31,00~~ | **€ 21,70**

Lame Rigide



Capacità
120
cc

Pressione
413
bar

**Modello
compatto**

421/120

Cod. U04210000

Mini compressore a leva per grasso

€ 21,50 | **€ 15,10**

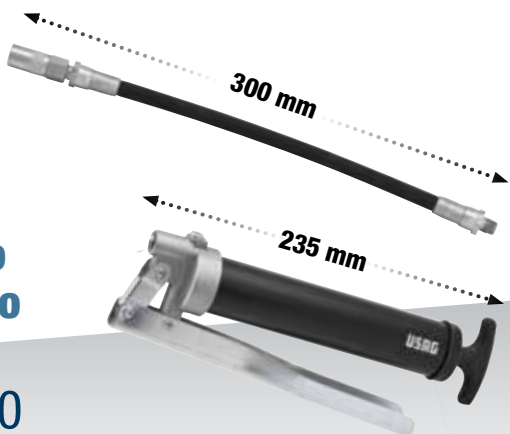

Capacità
500
cc

Pressione
400
bar

421

Cod. U04210002

Compressore a leva per grasso

€ 30,30 | **€ 21,30**



← 360
↑ 50
mm ↗ 210

M5÷M12

622 K/S1

Cod. U06220000

Assortimento per ripristino filetti

- Filettature: M5x0.8 - M6x1 - M8x1.25 - M10x1.5 - M12x1.75.
- Contiene punte in HSS-G da 13/64 - 6,3 - 21/64 - 10,3 - 31/64.

€ 226,00 | **€ 158,00**

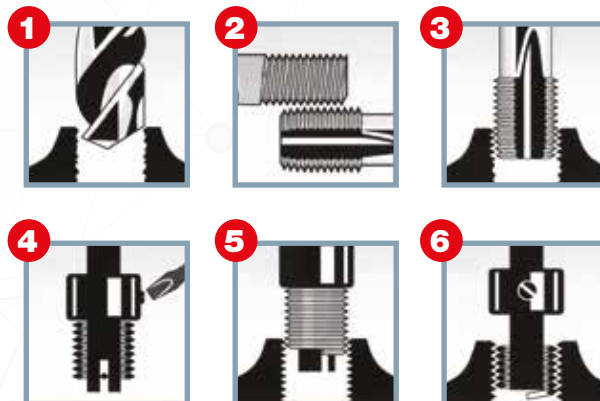

**LAMA IN
ACCIAIO INOX**

**CORPO IN
ALLUMINIO**

FRANGIVETRO

218 N

Cod. U02180002

Coltello multiuso

- Lunghezza lama: 72 mm.
- Lunghezza totale: 190 mm.

€ 30,00 | **€ 21,00**



DIN 338

HSS-G

14
PEZZI



988 LA/S14

Cod. U09880070

Assortimento di punte e maschi

- Ø punte: 2,5-3,3-4,2-5,0-6,8-8,5-10,2 mm.
- M maschi: 3x0,5-4x0,7-5x0,8-6x1-8x1,25-10x1,5-12x1,75 mm.

€ 76,00 | € 53,50

DIN 338

HSS-G

19
PEZZI



988 MA/S19

Cod. U09880073

Assortimento di punte

- Ø punte: 1,0-1,5-2,0-2,5-3,0-3,5-4,0-4,5-5,0-5,5-6,0-6,5-7,0-7,5-8,0-8,5-9,0-9,5-10,0 mm.

€ 46,10 | € 32,30

DIN 338

HSS-G

25
PEZZI



988 MA/S25

Cod. U09880074

Assortimento di punte

- Ø punte: 1,0-1,5-2,0-2,5-3,0-3,5-4,0-4,5-5,0-5,5-6,0-6,5-7,0-7,5-8,0-8,5-9,0-9,5-10,0-10,5-11,0-11,5-12,0-12,5-13,0 mm.

€ 91,50 | € 64,50



HSS

3
PEZZI



988 D/S3

Cod. U09880020

Serie di 3 frese a scalino

ART.	Ø SCALINI	Ø CODOLO	LUNG.
988 D1	4-5-6-7-8-9-10-11-12 mm	6 mm	65 mm
988 D2	4-6-8-10-12-14-16-18-20 mm	8 mm	75 mm
988 D3	4-6-8-10-12-14-16-18-20-22-24-26-28-30 mm	10 mm	100 mm

€ 169,00 | € 118,00

HSS

12
PEZZI



988 G/S12

Cod. U09880100

Serie di 10 seghe a tazza bimetalliche

- Ø 19-22-25-29-35-38-44-51-57-64 mm.
- Profondità di taglio max: 38 mm.

€ 173,00 | € 121,00

HSS

10
PEZZI



988 E/S10

Cod. U09880062

Frese rotative in metallo duro

- N°8 pezzi (Ø 10 e 12 forme EA-EC-EF-EG).
- N°2 pezzi (Ø 12 forme ED-EM).

€ 429,00 | € 199,00



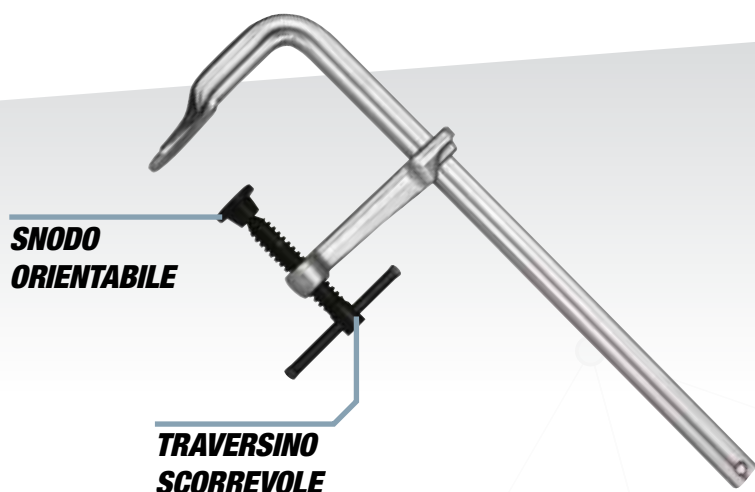

**SNODO
ORIENTABILE**

**TRAVERSINO
SCORREVOLE**

997 A

Strettoio a vite

- Corpo e asta scorrevole in acciaio forgiato.

CODICE	APERTURA	SEZIONE	PESO	
U09970002	160 mm	16x7,5 mm	0,5 kg	€ 24,10 € 16,90
U09970003	200 mm	19,5x9,5 mm	0,9 kg	€ 30,00 € 21,00
U09970004	250 mm	22x10,5 mm	1,2 kg	€ 36,00 € 25,20
U09970005	300 mm	25x12 mm	1,8 kg	€ 45,90 € 32,20
U09970006	400 mm	25x12 mm	1,9 kg	€ 47,90 € 33,60
U09970007	500 mm	25x12 mm	2,1 kg	€ 52,00 € 36,40
U09970008	600 mm	25x12 mm	2,3 kg	€ 56,50 € 39,60
U09970009	800 mm	27x13 mm	3,3 kg	€ 74,00 € 52,00
U09970010	1000 mm	27x13 mm	3,7 kg	€ 84,00 € 59,00

997 B

Strettoio rapido a leva

- Regolazione e sgancio rapidi tramite leva e pulsante integrato.
- Corpo e asta scorrevole in acciaio forgiato.

CODICE	APERTURA	SEZIONE	PESO	
U09970013	120 mm	13,5x6,5 mm	0,7 kg	€ 46,00 € 32,20
U09970014	160 mm	16x7,5 mm	1 kg	€ 50,50 € 35,40
U09970015	200 mm	19,5x9,5 mm	1,3 kg	€ 61,50 € 43,10
U09970016	250 mm	22x10,5 mm	1,9 kg	€ 71,00 € 49,70
U09970017	300 mm	25x12 mm	2,7 kg	€ 87,00 € 61,00
U09970018	400 mm	25x12 mm	2,8 kg	€ 91,00 € 64,00
U09970019	500 mm	25x12 mm	3 kg	€ 96,00 € 67,50

**PIANO
REGOLABILE**

**LEVA CON PULSANTE
DI SGANCIO INTEGRATO**



300 mm

**LAMA ORIENTABILE
A 45° E 90°**

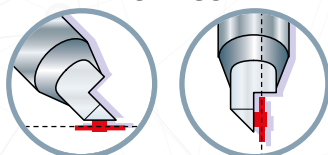

200 S

Cod. U02000002

Seghetto

- Anima in acciaio rivestita in materiale plastico antiscivolo ed antiurto
- Fornito con lama al cobalto mod. 200 C24

~~€ 30,70~~ | **€ 21,50**

SISTEMA DI TENSIONAMENTO DELLA LAMA
integrato nell'impugnatura



TUTTI I PRODOTTI DELLA LINEA USAG 493 SONO FABBRICATI IN ITALIA E RISPETTANO ELEVATI STANDARD DI SICUREZZA E DURATA



EN 1492-1



493 A

Fascia di sollevamento asola-asola doppio strato

- Coefficiente di sicurezza 7:1.
- Abbinamento colori e portate a norme EN 1492-1.

CODICE	PORTATA	LUNG.	€ 10,10	€ 7,10
U04930002	1 t	2 m	€ 14,90	€ 10,50
U04930003	1 t	3 m	€ 18,90	€ 13,30
U04930004	1 t	4 m	€ 23,00	€ 16,10
U04930005	1 t	5 m	€ 28,20	€ 19,80
U04930006	1 t	6 m	€ 19,40	€ 13,60
U04930012	2 t	2 m	€ 26,60	€ 18,70
U04930013	2 t	3 m	€ 33,00	€ 23,10
U04930014	2 t	4 m	€ 41,00	€ 28,70
U04930015	2 t	5 m	€ 47,90	€ 33,60
U04930016	2 t	6 m	€ 29,10	€ 20,40
U04930022	3 t	2 m	€ 40,00	€ 28,00
U04930023	3 t	3 m	€ 49,30	€ 34,60
U04930024	3 t	4 m	€ 59,50	€ 41,70
U04930025	3 t	5 m	€ 71,00	€ 49,70
U04930026	3 t	6 m		

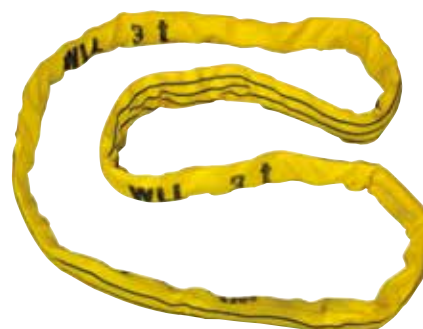

EN 1492-1



493 B

Fune di sollevamento tonda ad anello chiuso

- Struttura con guaina rinforzata antiusura.
- Coefficiente di sicurezza 7:1.
- Abbinamento colori e portate a norme EN 1492-1.

CODICE	PORTATA	LUNG.	€ 8,35	€ 5,90
U04930052	1 t	1 m	€ 11,20	€ 7,90
U04930053	1 t	1,5 m	€ 15,80	€ 11,10
U04930054	1 t	2 m	€ 19,10	€ 13,40
U04930055	1 t	2,5 m	€ 22,90	€ 16,10
U04930056	1 t	3 m	€ 11,00	€ 7,70
U04930062	2 t	1 m	€ 16,50	€ 11,60
U04930063	2 t	1,5 m	€ 21,50	€ 15,10
U04930064	2 t	2 m	€ 27,10	€ 19,00
U04930065	2 t	2,5 m	€ 31,50	€ 22,10
U04930066	2 t	3 m	€ 15,10	€ 10,60
U04930072	3 t	1 m	€ 22,60	€ 15,90
U04930073	3 t	1,5 m	€ 28,40	€ 19,90
U04930074	3 t	2 m	€ 34,90	€ 24,50
U04930075	3 t	2,5 m	€ 41,00	€ 28,70
U04930076	3 t	3 m		



EN 12195-2

493 C

Cinghie per ancoraggi

- Larghezza nastro 35÷50 mm.
- Tenditore a cricchetto da 35÷50 mm.
- Carico di ancoraggio 1000÷2000 N.
- Gancio ad uncino per i codici U04930102, U04930103, U04930104.
- Gancio a sponda a due dita per il codice U04930106.
- Norma di riferimento EN 12195-2.

CODICE	CARICO	NASTRO	€ 30,40	€ 21,30
U04930102	1000 N	35 mm x 4 m	€ 34,10	€ 23,90
U04930103	1000 N	35 mm x 5 m	€ 36,00	€ 25,20
U04930104	2000 N	50 mm x 8 m	€ 36,00	€ 25,20
U04930106	2000 N	50 mm x 10 m		

SCARPE ANTINFORTUNISTICHE S1P



Made in Italy

**S1P
SRC
ESD**

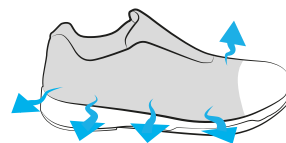

**TOMAIA
ALTAMENTE
TRASPIRANTE**

CALZATA

12

**100%
METAL
FREE**

3500 S1P

Scarpe antinfortunistiche con tomaia traspirante

- Categoria S1P.
- Calzatura bassa in Mesh con microfibra sovrastampata.
- Fodera 100% poliestere con lavorazione a nido d'ape per migliorare il ricircolo dell'aria a vantaggio della traspirazione.
- Puntale in composito leggero e resistente.
- Soletta estraibile preformata, in poliuretano bicolore e bi-densità, traspirante, lavabile ed antibatterica. Offre

ottime performance in termini di comfort e di ammortizzamento.

- Suola in poliuretano bi-densità resistente alle flessioni ed alle abrasioni, antiolio, antiscivolo.
- Intersuola confortevole antiperforazione.
- Calzata 12.
- 100% metal free.
- Campi di impiego suggeriti: Lavori leggeri, industria meccanica, logistica/imballaggio.

~~€ 103,00~~ | **€ 60,00**

CE EN ISO 20345: 2011

TAGLIA	CODICE
36	U35000036
37	U35000037
38	U35000038
39	U35000039
40	U35000040
41	U35000041

TAGLIA	CODICE
42	U35000042
43	U35000043
44	U35000044
45	U35000045
46	U35000046
47	U35000047

MID 2014/32/UE



981 A

Flessometri professionali con rivestimento antiurto

- Classe di precisione II.
- Cassa in ABS con rivestimento antiurto.

CODICE	L	NASTRO	SCALA	
U09810036	3 m	19 mm	mm	€ 9,15 € 5,90
U09810037	5 m	28 mm	mm	€ 15,60 € 8,40
U09810038	8 m	28 mm	mm	€ 18,20 € 11,90



984 MN

Livelle in alluminio con base magnetica

- Corpo in Alluminio verniciato con base d'appoggio rettificata.
- Fiale infrangibili (garanzia 5 anni).
- Liquido fluorescente, insensibile a temperature da -50° a +50° C.

CODICE	L	BASE	PRECISIONE	
U09840024	300 m	22 mm	0,057° = 1 mm/m	€ 25,60 € 18,00
U09840025	400 m	22 mm	0,057° = 1 mm/m	€ 27,30 € 19,10
U09840026	500 m	22 mm	0,057° = 1 mm/m	€ 33,10 € 23,20



- SMD LED
- IP20
- Lampada: 5 h
Torchia: 9 h
- 4,5 h
- IK07
- Li-ion

889 RD

Cod. U08890035

Lampada di ispezione a LED

~~€ 97,50~~ | **€ 68,00**



YouTube

DOPPIA FUNZIONE



LAMPADA



TORCIA

RICARICABILE

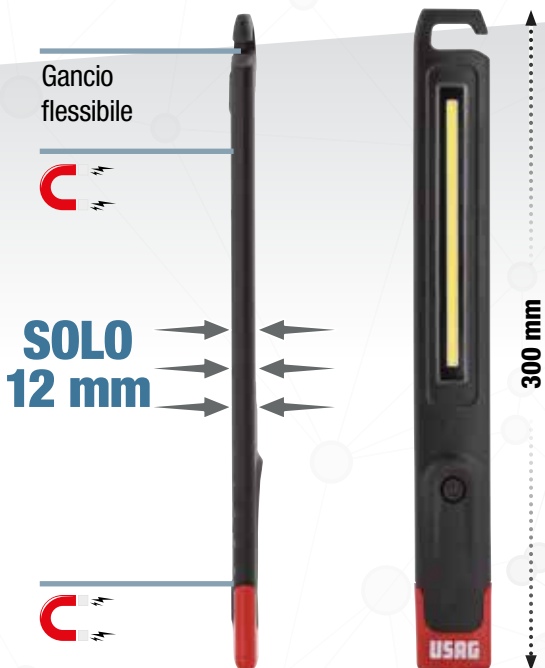

- COB LED
- IP54
- 2,5/5 h
- 4 h
- IK06
- Li-Poly

889 SA

Cod. U08890019

Lampada ispezione a LED extra sottile ad alta luminosità

~~€ 115,00~~ | **€ 80,00**



YouTube



RICARICABILE

USB



- SMD LED
- 2/5 h
- Li-ion
- IP54
- 6 h

889 TR

Cod. U08890073

Torcia LED in alluminio ricaricabile

~~€ 65,50~~ | **€ 45,90**



RICARICABILE

USB

360°



- Lampada COB LED
- Torcia SMD LED
- Lampada: 3h
Torcia: 10h
- IP20
- 4,5 h
- Li-ion

889 RP

Cod. U08890045

Lampada a LED ricaricabile compatta

~~€ 58,50~~ | € 41,00



YouTube

DOPPIA FUNZIONE



LAMPADA

TORCIA

RICARICABILE USB



YouTube

180°



- COB LED
- IP67
- 2,5 h
- 1 = 8 h
2 = 4 h
3 = 2,5 h
- IK07
- Li-ion

889 RT

Cod. U08890038

Faretto a LED ricaricabile - certificato IP67

~~€ 253,00~~ | € 177,00

3 LIVELLI DI LUMINOSITÀ



**FUNZIONA
CON O
SENZA CAVO!**

Cavo da 5
metri incluso.

500, 1000 e 1500 lumen
con un semplice tocco.



- COB LED
- IP54
- 24/6,5 h
- 3xAAA

889 LTE

Cod. U08890014

Lampada frontale a LED

~~€ 55,50~~ | € 29,90



ORIENTABILE



CINTURINO
ANTISCIVOLO



SENSORE DI
MOVIMENTO



MANUTENZIONE AUTO IBRIDE ED ELETTRICHE LE OPERAZIONI PRINCIPALI PER L'AUTOFFICINA:



MESSA IN SICUREZZA

Escludere la tensione dell'impianto elettrico per poter effettuare la manutenzione del veicolo.



MANUTENZIONE CELLE BATTERIE

Sostituire le singole celle usurate per ricondizionare il pacco batterie.



LO SAPEVI CHE...

- A.** Auto ibride ed elettriche montano impianti elettrici con **tensioni elevate e potenzialmente pericolose (oltre 200 V in CC e 600 V in CA)**.
- B.** Gli interventi di manutenzione su auto ibride ed elettriche sono equivalenti a **lavori elettrici su sistemi di categoria 0 e 1**, come definito nel D. Lgs 81/08 - normativa tecnica di riferimento CEI 11-27.
- C.** È necessario utilizzare attrezzatura **con isolamento 1000 V come: utensili, guanti, sovraguanti e tappetino** per garantire la sicurezza durante le operazioni.



IL NECESSARIO PER LA MESSA IN SICUREZZA

NEW



8
PEZZI

3/8"

↔ 435
↑ 70
mm ↘ 270

098 3/8" HYB8 
Cod. U00980508

Assortimento in cassetta di ABS per MESSA IN SICUREZZA AUTO IBRIDE ed ELETTRICHE

- Cassetta in ABS ad alta resistenza con sistema di chiusura rapida.

DESCRIZIONE	ART./MISURA	PZ.
Chiavi a bussola con bocca poligonale 1000 V	098 3/8" 8-10-12	3
Cricchetto reversibile 1000 V	098 A 3/8"	1
Prolunga 1000 V	098 B 3/8" 150	1
Pinza 1000 V	081 EX 200	1
Giravite per viti a intaglio 1000 V	091 1x5,5x125	1
Giravite per viti a impronta PHILLIPS® 1000 V	091 PH 2x125	1

~~€ 317,50~~ | **€ 239,00**

NEW

ASSORTIMENTO PER MESSA IN SICUREZZA E MANUTENZIONE CELLE BATTERIE!



519 M 098HYB8

519 M 098HYB11

076 G

20
PEZZI



495 098HYB
Cod. U04958010

Assortimento per MESSA IN SICUREZZA e MANUTENZIONE CELLE BATTERIE - 1 cassetto

DESCRIZIONE	ART	PZ
Bussole poligonali 1000 V (8-10-12 mm), cricchetto 1000 V (098 A 3/8), prolunga 3/8" 1000 V, giraviti 1000 V e pinza 1000 V	519 M 098HYB8	8
Bussole poligonali 1000 V (11-13-14 mm), chiavi poligonali 1000 V (8-10-12-13-14 mm) e giraviti 1000 V	519 M 098HYB11	11
Tester di tensione	076 G	1

~~€ 765,00~~ | **€ 499,00**



**5 CASSETTI
3 MODULI**



NEW

20
PEZZI



516 SP5HYA-S
Cod. U05168024

Carrello START per MESSA IN SICUREZZA e MANUTENZIONE CELLE BATTERIE - 1 cassetto

DESCRIZIONE	ART	PZ
Bussole poligonali 1000 V (8-10-12 mm), cricchetto 1000 V (098 A 3/8), prolunga 3/8" 1000 V, giraviti 1000 V e pinza 1000 V	519 M 098HYB8	8
Bussole poligonali 1000 V (11-13-14 mm), chiavi poligonali 1000 V (8-10-12-13-14 mm) e giraviti 1000 V	519 M 098HYB11	11
Tester di tensione	076 G	1

~~€ 1.331,00~~ | **€ 879,00**



NUOVI AVVIATORI PORTATILI

TRASFORMATORE INTEGRATO

Nessun alimentatore esterno.



BATTERIA AGM
(Absorbed Glass Mat)

12 V

1200 A



3500 A

LUNGHEZZA CAVI 155 cm

PULSANTE TEST

Indicazione semaforica a LED dello stato di carica della batteria.

NEW



YouTube

1613 RA12

Cod. U16130019

Avviatore portatile 12V

- Scocca antiurto in ABS.
- Idoneo anche per batterie sigillate.
- Pinze diritte.
- Fornito con cavo di ricarica.

~~€ 504,00~~ | **€ 350,00**



VANO PER CAVO RICARICA E ACCENDISIGARI



FUSIBILE ESTERNO

Protezione da sovracorrente fino a 300A. Facile da sostituire in caso di sovraccarico.

CONNETTORE POSTERIORE PER SELEZIONE VOLTAGGIO



BATTERIA AGM
(Absorbed Glass Mat)

12 V
24 V

1400 A
700 A



12V - 3700 A

24V - 1860 A

LUNGHEZZA CAVI 155 cm

FUSIBILE ESTERNO

Protezione da sovracorrente fino a 300A.

NEW

1613 AGM 12-24

Cod. U16130013

Avviatore professionale portatile 12V-24V

- Scocca antiurto in ABS.
- Protezione da sovratensione.
- Idoneo anche per batterie sigillate.
- Pinze inclinate.
- Fornito con caricatore di rete e cavo presa accendisigari.

~~€ 1.142,00~~ | **€ 799,00**



VOLTMETRO

per indicazione dello stato di carica della batteria interna.

PER BATTERIE 6÷12 V

Anche per sistema
Start & Stop



890 K

Cod. U08901000

Tester digitale per batterie con stampante

~~€ 603,00~~ | **€ 422,00**

12 V



1612 BA12

Cod. U16120006

Proteggi centraline 12 V

- Protegge le centraline durante le operazioni di saldatura, avviamento con caricabatterie o avviatori, avviamento con cavi.

~~€ 74,50~~ | **€ 52,00**

E-OBD OBD-II

⚠ IMPORTANTE ⚠

Utilizzare questo accessorio solo con avviatori da 12V.



1613 OBD

Cod. U16130003

Cavo OBD salva-memorie 12 V

~~€ 47,10~~ | **€ 33,00**

12 V

24 V



1612 BA24

Cod. U16120007

Proteggi centraline 24 V

- Protegge le centraline durante le operazioni di saldatura, avviamento con caricabatterie o avviatori, avviamento con cavi.

~~€ 74,50~~ | **€ 52,00**

Range di misura: -60÷625°
Rapporto ottico: 16:1



Compatibile
con termocoppia K.



YouTube



1651

Cod. U16510001

Termometro digitale ad infrarossi

~~€ 162,00~~ | **€ 113,00**



22
PEZZI



1881 S22

Cod. U18810082

Kit universale per lo smontaggio e il montaggio
delle ghiera pulegge alternatori

- Fornito in cassetta di plastica

~~€ 120,00~~ | **€ 84,00**

KIT UNIVERSALE PER LA RIMOZIONE DI DADI E VITI ANTIFURTO



10
PEZZI

272 DS
Cod. U02720001

Kit estrazione dadi e viti antifurto

- Non danneggia il cerchio in lega.
- Punte speciali al carburo di tungsteno in grado di forare qualsiasi tipo di materiale (lubrificare con olio da taglio ad ogni utilizzo).
- Bussole coniche per centraggio/estrazione super sottili per accedere su ogni tipo di cerchio in lega.

~~€ 273,00~~ | **€ 190,00**

YouTube
**VIDEO
TUTORIAL**



**ESTRATTORE PROGETTATO
PER RESISTERE 150 Nm:
IDEALE PER VITI BMW.**

Dadi e viti antifurto standard:
**svita velocemente con
le bussole coniche.**



Dadi e viti con anello girevole:
**fora ed estrai in sicurezza
con gli utensili speciali.**



447 T
Cod. U04470101

Smonta ammortizzatori pneumatico

- Ideale per autovetture.
- Sistema di autolivellamento dei bracci superiori: adatto anche a molle coniche e disassate.
- Boccole autolubrificanti: nessuna operazione di lubrificazione e/o ingrassaggio sulle colonne di scorrimento.
- Fornito con due staffe inferiori 447 TC1 (78÷130 mm) e 447 TC2 (105÷182 mm), morsa 447 TA e morsetti superiori universali 447 TB1.



YouTube

**POTENZA DI
COMPRESSIONE**
**735 kg (6 bar),
1226 kg (10 bar).**

CARATTERISTICHE TECNICHE

Potenza compressione	735 kg (6 bar) - 1226 kg (10 bar)
Pressione di esercizio	6÷10 bar
Corsa del pistone	420 mm
Cilindro	Doppio in lega d'alluminio e resina al nylon



~~€ 1.705,00~~ | **€ 1.179,00**

CONFORMITÀ ALLA DIRETTIVA MACCHINE

Gli smontammortizzatori pneumatici USAG sono progettati per rispondere pienamente alla Direttiva Macchine 2006/42/CE. Alcune funzionalità della macchina sono state impostate perché l'operatore possa lavorare in totale sicurezza:

- Protezione frontale di sicurezza.
- Dispositivo di arresto del pistone in caso di apertura della protezione frontale.
- Velocità limitata: sempre inferiore ai 10 cm/sec.
- Sistema di blocco delle ganasce e del pistone in caso di interruzione dell'alimentazione dell'aria.



3
PEZZI

1 1/2"

270 C/C3
Cod. U02700106

Assortimento in cassetta modulare con bussole macchina per cerchi in lega con protezione in teflon

~~€ 51,00~~ | **€ 35,70**

← 190
↑ 58
mm ↗ 144

17 19 21

NEW

1 1/2"



Mercedes-Benz

19,35 mm

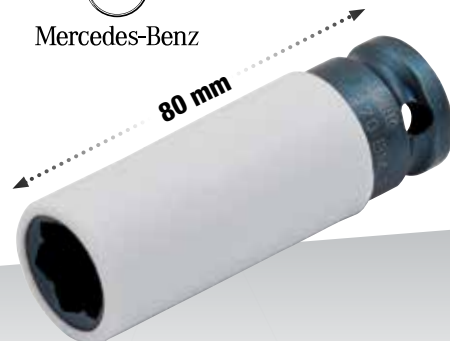

270 BM
Cod. U02700140

Chiave a bussola per dadi ruota Mercedes

- Adatta per i modelli: Classe C e GLK (W204), Classe E (W211, W212, W207), Classe SLK (W172), Classe ML (W164, W166), Classe CL (W216), Classe S (W221, W222).

~~€ 11,90~~ | **€ 8,40**



RIVESTIMENTO PROTETTIVO

Lo speciale rivestimento in teflon riduce il rischio di danneggiamento quando si opera su cerchi in lega di alluminio.



CODICE COLORE

ogni misura è facilmente riconoscibile grazie al colore del rivestimento in teflon.



10
PEZZI



YouTube



425 TPMS
Cod. U04250005

1,2 kg | 360 mm | 65 mm | 160 mm

Kit di utensili per montare e smontare le valvole pneumatici con sistema di controllo della pressione

~~€ 267,00~~ | **€ 187,00**



1,4÷10 Nm

Universale per tutti i tipi di valvole TPMS

CEE 86/217

SCALA GRADUATA
in bar/psi



927 MN
Cod. U09270003

Pistola di gonfiaggio con manometro

~~€ 79,50~~ | **€ 56,00**

NEW

236 K per bussole



MASSIMA ACCESSIBILITÀ
DIMENSIONI TESTA COME UN
CRICCHETTO*.



39 mm

*Confronto con cricchetto da 1/2".



YouTube

236 KE per inserti



MINIMO INGOMBRO
INNESTO DIRETTO PER
INSERTI MACCHINA.



Anello di tenuta
in acciaio integrato.



YouTube

UTILIZZABILI CON CRICCHETTO O AVITATORE

BUSSOLE



236 K

Prolunga a catena in alluminio per bussole

CODICE	□	L	H	📏
--------	---	---	---	---

U02360700 1/2" 340 mm 39 mm 1,1 kg € 101,00 | **€ 70,00**

U02360698 1/4" 260 mm 27 mm 300 g € 76,00 | **€ 50,00**



13
PEZZI



236 K/C13

Cod. U02360852



Assortimento in cassetta modulare
con bussole esagonali macchina

~~€ 242,50~~ | **€ 170,00**

3 kg | mm | 435
70
270

INSERTI



236 KE

Prolunga a catena in alluminio per inserti

CODICE	□	◇	L	H	📏
--------	---	---	---	---	---

U02360705 1/2" 1/2" 340 mm 24 mm 1,1 kg € 101,00 | **€ 70,00**

U02360710 1/4" 1/4" 260 mm 19 mm 300 g € 76,00 | **€ 50,00**



NEW



18
PEZZI



NEW

236 KE/C18

Cod. U02360890



Assortimento in cassetta
modulare con inserti macchina

~~€ 350,50~~ | **€ 170,00**

3 kg | mm | 435
70
270

PRESSIONE REGOLABILE FINO A 4 BAR



2847/3

Cod. U28470084

12 V

Spurgatore per circuito freni

- Permette di cambiare, riempire, spurgare i circuiti dei freni di autovetture e veicoli industriali.
- Apparecchio progettato esclusivamente per liquidi freno tipo DOT 3, DOT 4, DOT 5.1. No LHM.
- Pressione regolabile fino a 4 bar.
- Arresto automatico al 10% del serbatoio (1 L).
- Alimentazione 12 V tramite cavi batteria.
- Vano posteriore accessori.
- Ruote integrate e maniglione per un facile trasporto.

Fornito con:

- guarnizioni di ricambio,
- 1 tappo multidiametro 44-45-46 mm (2847 N11).
- 1 contenitore di recupero olio.

~~€ 1.346,00~~ | **€ 942,00**

CARATTERISTICHE TECNICHE

Sistema di manovra del liquido	Pompa peristaltica (nessun contatto diretto pompa liquido, nessuna pressione aria sul liquido)
Alimentazione	12 V (morsetti batteria)
Capacità serbatoio	10 litri
Limitatore di pressione	4 bar
Tubo a spirale	4 m (elastico)
Cavo di alimentazione	4 m



2847 N4

Cod. U28470098Q

Tappo adattatore universale

- Per spurgafreni 2847/3.

~~€ 150,00~~ | **€ 109,00**



21
PEZZI

2800 S21

Cod. U28000085

Kit di 21 utensili per pistoncini freni

- Compatibile con i seguenti modelli d'auto: Citroen, Audi, Fiat/Alfa Romeo, Ford, Isuzu, Honda, Jaguar, Bmw, Mercedes, Mitsubishi, Nissan, Rover, Toyota, Volvo, Volkswagen, Mazda, Saab, Gm, Subaru, Peugeot, Renault, Mini, Opel.

~~€ 155,00~~ | **€ 109,00**



6
PEZZI

1 1/2"

NEW

14-16-18

233 1/2" MXZN/C6

Cod. U02332513



Assortimento in cassetta di ABS con bussole macchina XZN corte e lunghe

- Ideale per pinze freno VW Touareg (asse posteriore) oppure per Mercedes Atego (truck).
- 233 1/2 MXZN/14-16-18-14L-16L-18L.

~~€ 92,60~~ | **€ 65,00**

443 N CHIAVE AUTOMATICA PER FILTRI OLIO

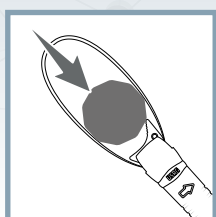

**SERRAGGIO AUTOMATICO
DEL NASTRO**

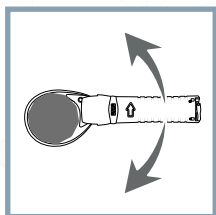

EFFETTO CRICCHETTO
Rapidità d'uso anche in spazi ridotti.

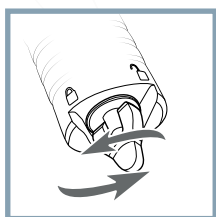

**LEVA DI INCREMENTO
POTENZA SERRAGGIO**



YouTube



443 N

66÷105 mm



Cod. U04430005

Chiave automatica a ripresa rapida per
filtri olio (autovetture)

~~€ 91,00~~ | **€ 64,00**

443 NC

106÷150 mm



Cod. U04430007

Chiave automatica a ripresa rapida per
filtri olio (veicoli industriali)

~~€ 105,00~~ | **€ 73,50**



YouTube

446 E/SE2

Cod. U04460015



Serie di 2 chiavi autoserranti per filtri olio
• 446 E/60÷80-80÷100 mm

~~€ 143,00~~ | **€ 100,00**



80
Litri



263 RA

Cod. U02631600

Recuperatore olio

- Modello a caduta.
- Indicatore laterale per la verifica del livello olio nel serbatoio.
- Griglia in materiale plastico all'interno della coppa.
- Sistema di svuotamento del serbatoio con aria compressa (max 3,5 bar).
- Tubo di scarico flessibile lungo 1800 mm.
- 4 ruote pivotanti: \varnothing 70 mm.

~~€ 531,00~~ | **€ 290,00**



Compatibile con liquido freni DOT ed antigelo



Tubo esterno antiurto in poliuretano per il controllo del serbatoio



Blocco di giunzione in metallo con guarnizione interna in EPDM

Attacco per il recuperatore d'olio



16
PEZZI

3/8"

263/S16

Cod. U02631400

Kit per tappi olio

- Bussole magnetiche.
- 1 chiave snodata con coppetta.
- 2 inserti \varnothing 8-10 mm.
- 6 inserti \varnothing 8-10-12-13-14-17 mm.
- 6 bussole \varnothing 13-14-17-18-19-21 mm.
- 1 inserto \varnothing T45.

~~€ 164,00~~ | **€ 115,00**



VASCHETTA RACCOGLI OLIO INTEGRATA

3/8"



263 VAG

Cod. U02631150

Bussola per tappi olio Audi e Volkswagen

- Quadro di manovra: 3/8"
- Per lo svitamento e la rimozione dei nuovi tappi olio in plastica montati su tutte le nuove vetture Audi e Volkswagen
- Utilizzabile sui seguenti modelli di auto:
 - Audi A1, A3, A4, A5, A6, A7, Q3, Q5, Q7, TT, TTS
 - Seat Alhambra, Leon, Toledo
 - Skoda Octavia, Rapid, Superb, Yeti
 - Volkswagen Maggiolino, Caddy, CC, Golf, Jetta, Passat, Polo, Scirocco, Sharan, Tiguan, Touran

~~€ 15,50~~ | **€ 10,90**



3
TON

30,5
kg

CE

3t

2550 A

Cod. U25500001

Sollevatore idraulico 3T per auto e veicoli commerciali

- Struttura in acciaio.
- Polivalente e compatto.
- Portata elevata per utilizzo su auto, fuoristrada e furgoni.
- Sistema a doppia pompa per sollevare più velocemente la vettura.
- Dotato di comando di discesa manuale.
- Valvola di spurgo dell'aria, per evitare il pericolo di over-carico.
- Impugnatura con gomma antiurto.
- Ruote in poliuretano.

~~€ 297,00~~ | **€ 199,00**



COMPATTO

615 mm di lunghezza.



133÷465
mm



Sottile

75 mm di altezza.



75÷505
mm



2
TON

32,5
kg

CE

2t

2550 B

Cod. U25500002

Sollevatore idraulico 2T

- Struttura in acciaio.
- Per utilizzo in spazi ridotti.
- Sistema a doppia pompa per sollevare più velocemente la vettura.
- Dotato di pedale di avvicinamento.
- Dotato di comando di discesa manuale.
- Valvola di spurgo dell'aria, per evitare il pericolo di over-carico.
- Impugnatura con gomma antiurto.
- Ruote in poliuretano.

~~€ 419,00~~ | **€ 295,00**



Pedale di avvicinamento



1950 C

Coppia colonnette

- Altezza regolabile tramite meccanismo dentato con rilascio a leva.
- Perno di bloccaggio con catena.
- 1950 C/3: modello regolabile a 10 posizioni.
- 1950 C/6: modello regolabile a 13 posizioni.

CODICE	PORTATA	H MAX	H MIN	DIMENSIONI	PESO
U19501001	3 t	427 mm	300 mm	207x188 mm	7 kg
U19501002	6 t	620 mm	400 mm	285x250 mm	14 kg

€ 82,50 | **€ 58,00**

€ 119,00 | **€ 83,50**



2 in 1

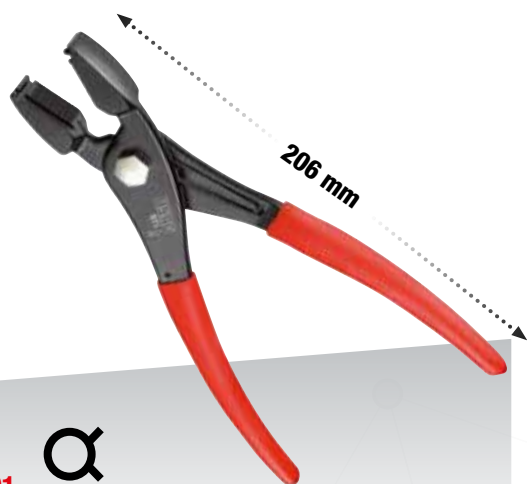

871 D

Cod. U08710001



Pinza per anelli stringitubo a presa frontale/laterale

- Possibilità di aggancio frontale o laterale.
- Ganasce con superficie di presa zigrinata.

~~€ 47,30~~ | **€ 33,20**

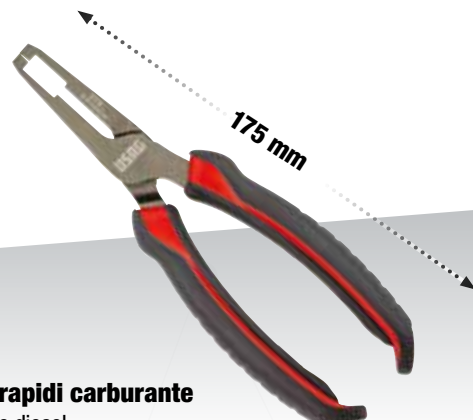

870 C

Cod. U08700006

Pinza per raccordi rapidi carburante

- Per veicoli a benzina e diesel.
- Impugnature ergonomiche bimalteriali.

~~€ 57,00~~ | **€ 39,90**

3 posizioni
di lavoro

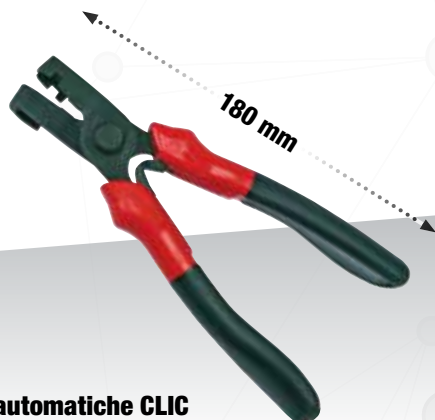

871 C

Cod. U08719005P

Pinza per fascette automatiche CLIC

- Testa triassiale per lavorare in tutte le posizioni.
- Permette di aprire o chiudere le fascette automatiche presenti sui circuiti del carburante, dei collettori d'aspirazione e dei circuiti idraulici.

~~€ 67,00~~ | **€ 46,90**



468 M

Utensile a percussione per anelli di tenuta e guarnizioni

- Semplifica l'inserimento di anelli di supporto esterni per cuscinetti obliqui.
- Asse, sede dei cuscinetti e anelli di tenuta non vengono danneggiati.
- Ghiera regolabile in 3 posizioni.
- Impugnatura in acciaio.

CODICE	CAPACITÀ	LUNGHEZZA	
U04680150	9,5÷50 mm	176 mm	€ 89,50 € 63,00
U04680151	18÷90 mm	210 mm	€ 112,00 € 78,50

9
PEZZI

Due spazzole metalliche
Ø 20mm e 25mm



885 F

Cod. U08850004

Kit pulizia iniettori

- Ideale per la pulizia del condotto degli iniettori montati su motori common rail.

~~€ 149,00~~ | **€ 104,00**

6
PEZZI

1/2"



884 C/S6

Cod. U08841000

Serie di 6 chiavi per raccordi tubi iniettori

- Per montaggio/smontaggio dei raccordi tubi iniettori.
- Lunghezza: 98 mm.
- Misure: 12-14-16-17-18-19 mm.

~~€ 112,00~~ | **€ 78,50**

12
PEZZI

UNIVERSALE PER AIRBAG



426 SAB

Cod. U04260010

Kit manutenzione Airbag

- Adatto per i seguenti modelli di auto: VW Bora, Golf 4, Jetta, Lupo, New Beetle, Passat B5, Polo; Audi A4, A6; BMW; Mercedes-Benz; Opel; Renault; Seat; Skoda Fabia, Octavia, Superb.

~~€ 69,00~~ | **€ 48,30**

4
PEZZI

Per la rimozione di
contrappesi, silicone,
modanature etc



426 C/S4

Cod. U04260007

Kit di 4 raschietti multiuso in plastica

~~€ 29,60~~ | **€ 20,80**

4
PEZZI

Per separare i carter della
cinghia di distribuzione,
testata motore, cinghia di
trasmissione etc.



426 D/S4

Cod. U04260005

Kit di 4 scalpelli separatori in plastica

~~€ 23,70~~ | **€ 16,60**

5
PEZZI

Per la rimozione di
modanature, pioli, parti
di cruscotto, rivestimenti
portiere, etc.



426 B/S5

Cod. U04260006

Kit di 5 utensili per componenti in plastica

~~€ 27,70~~ | **€ 19,40**

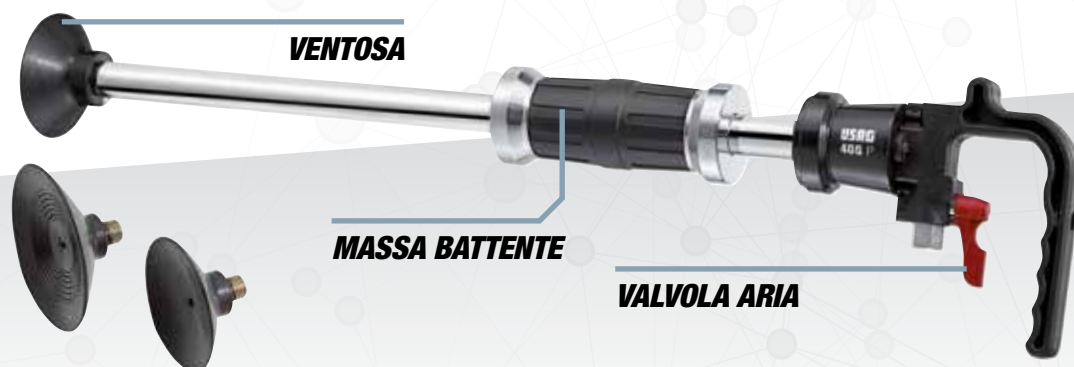

CARATTERISTICHE TECNICHE

Attacco filettatura	M18
Livello sonoro	78 Db
Lunghezza totale	610 mm
Peso	4 Kg
Pressione di esercizio	6,2 bar
Attacco filettato	1/4"

400 P

Cod. U04000010

Aspiratore pneumatico ammaccature

- Ideale per eliminare ammaccature da parti sciolate senza la necessità di rivernicare.
- Fornito con 3 ventose (Ø 75-100-125 mm), in valigetta in materiale plastico dotata di maniglia per il trasporto e clip di chiusura.

~~€ 178,00~~ | **€ 125,00**



9,5

Litri



4,1 kg | 230 mm | 627 mm | 302 mm

1785 B

Cod. U17850005

Aspiratore liquidi manuale e pneumatico

CARATTERISTICHE TECNICHE

Pressione aria raccomandata	5÷8 bar
Range temperatura liquidi aspirati	1÷100 °C
Capacità serbatoio	9,5 litri
Accessori contenuti	1 tubo principale 1500 x Ø 16 mm - 4 tubi di aspirazione: 400 x Ø 9,5 mm, 700 x Ø 6 mm, 850 x Ø 7, 700 x Ø 6

~~€ 200,00~~ | **€ 140,00**



4,6 kg | 1.030 mm | 480 mm | 115 mm



2000 A

Cod. U20000100

Letto sottoscocca 6 ruote

- Cuscino poggiatesta in vinile resistente agli idrocarburi.
- Struttura in materiale plastico resistente agli idrocarburi, lavabile.
- Due vaschette porta utensili laterali.
- Altezza massima da terra: 115mm.
- Fornito con 6 ruote in gomma pivotanti Ø 80mm (da montare).

~~€ 107,00~~ | **€ 75,00**

250 coprisedili



3781 E

Cod. U38000075

Coprisedili

- In polietilene
- In formato doppio, riveste tutto il sedile compresa la parte posteriore
- Spessore: 13 micron
- Dimensioni: 70x165 cm

~~€ 104,00~~ | **€ 75,00**

250 tappetini

1 bobina coprivolante



250 coprisedili

3781 A

Cod. U38000072

Set service

- Fornito con espositore murale.

~~€ 373,00~~ | **€ 199,00**

3781 C

Cod. U38000073

Tappetino per officina

- Salvamoquette in carta di tipo assorbente
- Dimensioni: 45x35 cm

~~€ 103,00~~ | **€ 75,00**



3781 D

Cod. U38000074

Coprivolante

- Per la protezione del volante durante la permanenza del veicolo in officina
- Materiale: film estensibile
- Dotate di srotolatore in plastica

~~€ 46,90~~ | **€ 29,00**



ILLUMINAZIONE A LED

1.898 Nm  2,2 kg



 YouTube

CARTER IN LEGA DI MAGNESIO



TOP DI GAMMA

943 PC1 1/2" 
Cod. U09430001

Avvitatore ad impulsi in magnesio

~~€ 439,00~~ | **€ 299,00**

CARATTERISTICHE TECNICHE

Attacco quadro	1/2"	Pressione aria raccomandata	6,2 bar
Capacità bullone	M20	Pressione sonora	94 ±3 dB(A)
Coppia massima	1.898 Nm	Potenza sonora	105 ±3 dB(A)
Coppia di lavoro	320÷460 Nm	Vibrazioni	6,4 m/s ²
Impulsi al minuto	1200	Attacco aria	1/4"
Velocità a vuoto	6.500 giri/min	Diametro interno tubo aria	10 mm
Consumo medio aria	172 l/min	Peso	2,2 kg

CARTER IN LEGA DI MAGNESIO

1.600 Nm  2 kg



 YouTube



IL RIFERIMENTO

929 PC1 1/2" 
Cod. U09290001

Avvitatore ad impulsi in magnesio

~~€ 338,00~~ | **€ 230,00**

CARATTERISTICHE TECNICHE

Attacco quadro	1/2"	Pressione aria raccomandata	6,2 bar
Capacità bullone	M16	Pressione sonora	93 ±3 dB(A)
Coppia massima	1.600 Nm	Potenza sonora	104 ±3 dB(A)
Coppia di lavoro	280÷440 Nm	Vibrazioni	6,2 m/s ²
Impulsi al minuto	1.300	Attacco aria	1/4"
Velocità a vuoto	7.000 giri/min	Diametro interno tubo aria	10 mm
Consumo medio aria	172 l/min	Peso	2,0 kg

11 cm



EXTRA COMPATTO

942 PC3 1/2" 
Cod. U09420012

Avvitatore ad impulsi - extra compatto

~~€ 218,00~~ | **€ 159,00**

CARATTERISTICHE TECNICHE

Attacco quadro	1/2"	Pressione aria raccomandata	6,2 bar
Capacità bullone	M16	Pressione sonora	91,1±3 dB(A)
Coppia massima	861 Nm	Potenza sonora	108,1±3 dB(A)
Coppia di lavoro	150÷220 Nm	Vibrazioni	9,57 m/s ²
Impulsi al minuto	1650	Attacco aria	1/4"
Velocità a vuoto	10.000 giri/min	Diametro interno tubo aria	10 mm
Consumo medio aria	127 l/min	Peso	1,3 kg

861 Nm  1,3 kg



 YouTube



NEW

Modulare con i cassetti
dei carrelli USAG

1 1/2"

12
PEZZI



943 PC1/C12

Cod. U09430005



Assortimento in cassetta modulare con
avvitatore ad impulsi e bussole macchina

€ 588,00 | € 368,00

DESCRIZIONE	ART./MISURA	PZ.
Avvitatore ad impulsi in magnesio	943 PC1 1/2	1
Chiavi a bussola macchina con bocca esagonale	235 1/2 M/ 10-13-17-18-19-22-24-27-30-32 mm	10
Spina di tenuta	235 MCA/4-6	2
Anello di sicurezza	235 MDA/4-6	2
Prolunghe macchina	236 1/2 M/125	1



NEW

Modulare con i cassetti
dei carrelli USAG

1 1/2"

12
PEZZI



929 PC1/C12

Cod. U09290005



Assortimento in cassetta modulare con
avvitatore ad impulsi e bussole macchina

€ 487,00 | € 299,00

DESCRIZIONE	ART./MISURA	PZ.
Avvitatore ad impulsi in magnesio	929 PC1 1/2	1
Chiavi a bussola macchina con bocca esagonale	235 1/2 M/ 10-13-17-18-19-22-24-27-30-32 mm	10
Spina di tenuta	235 MCA/4-6	2
Anello di sicurezza	235 MDA/4-6	2
Prolunghe macchina	236 1/2 M/125	1



NEW

Modulare con i cassetti
dei carrelli USAG

1 1/2"

7
PEZZI



942 PC3/C7

Cod. U09420015



Assortimento in cassetta modulare con
avvitatore ad impulsi e bussole macchina

€ 290,00 | € 199,00

DESCRIZIONE	ART./MISURA	PZ.
Avvitatore ad impulsi - extra compatto	942 PC3 1/2	1
Chiavi a bussola macchina con bocca esagonale	235 1/2 M/ 13-17-19-21-22-24 mm	6
Spina di tenuta	235 MCA/4	1
Anello di sicurezza	235 MDA/4	1

ILLUMINAZIONE A LED

CARTER IN LEGA DI MAGNESIO

CORPO IN ALLUMINIO

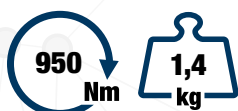

943 PC2 1/2"
Cod. U09430002



Avvitatore ad impulsi in magnesio con LED - Extra compatto

~~€ 374,00~~ | **€ 262,00**

CARATTERISTICHE TECNICHE

Attacco quadro	1/2"	Pressione aria raccomandata	6,2 bar
Capacità bullone	M16	Pressione sonora	95±3 dB(A)
Coppia massima	950 Nm	Potenza sonora	107±3 dB(A)
Coppia di lavoro	200÷270 Nm	Vibrazioni	3,9 m/s ²
Impulsi al minuto	1400	Attacco aria	1/4"
Velocità a vuoto	10.000 giri/min	Diametro interno tubo aria	10 mm
Consumo medio aria	167 l/min	Peso	1,4 kg

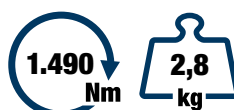

928 AC1 1/2"
Cod. U09280014



Avvitatore ad impulsi in alluminio

~~€ 267,00~~ | **€ 185,00**

CARATTERISTICHE TECNICHE

Attacco quadro	1/2"	Pressione aria raccomandata	6,2 bar
Capacità bullone	M16	Pressione sonora	90 ±3 dB(A)
Coppia massima	1.490 Nm	Potenza sonora	101 ±3 dB(A)
Coppia di lavoro	135÷380 Nm	Vibrazioni	5,2 m/s ²
Impulsi al minuto	1.120	Attacco aria	1/4"
Velocità a vuoto	6.500 giri/min	Diametro interno tubo aria	10 mm
Consumo medio aria	147 l/min	Peso	2,8 kg

TESTA PIATTA E COMPATTA ideale per l'uso in spazi ristretti.



913 PB2 3/8"
Cod. U09130011



Cricchetto in materiale composito

CARATTERISTICHE TECNICHE

Attacco quadro	3/8"	Pressione sonora	92±3 dB(A)
Capacità bullone	M10	Potenza sonora	103±3 dB(A)
Coppia massima	54 Nm	Vibrazioni	3,9 m/s ²
Velocità a vuoto	300 giri/min	Attacco aria	1/4"
Consumo medio aria	110 l/min	Diametro interno tubo aria	6 mm
Pressione aria raccomandata	6,2 bar	Peso	0,5 kg

~~€ 141,00~~ | **€ 99,00**

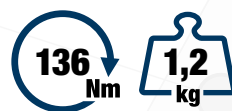

913 PC2 1/2"
Cod. U09130017



Cricchetto in materiale composito

CARATTERISTICHE TECNICHE

Attacco quadro	1/2"	Pressione sonora	99±3 dB(A)
Capacità bullone	M10	Potenza sonora	110±3 dB(A)
Coppia massima	136 Nm	Vibrazioni	9,1 m/s ²
Velocità a vuoto	280 giri/min	Attacco aria	1/4"
Consumo medio aria	113 l/min	Diametro interno tubo aria	10 mm
Pressione aria raccomandata	6,2 bar	Peso	1,2 kg

~~€ 213,00~~ | **€ 149,00**

CARTER IN LEGA DI TITANIO



2.115 Nm
3,8 kg

942 PD1 3/4" 3/4"

Cod. U09420004

Avvitatore ad impulsi in titanio

~~€ 784,00~~ | **€ 549,00**

CARATTERISTICHE TECNICHE

Attacco quadro	3/4"	Pressione aria raccomandata	6,2 bar
Capacità bullone	M27	Pressione sonora	97,8±3 dB(A)
Coppia massima	2.115 Nm	Potenza sonora	108,8±3 dB(A)
Coppia di lavoro	500÷800 Nm	Vibrazioni	5,06 m/s ²
Impulsi al minuto	950	Attacco aria	3/8"
Velocità a vuoto	5.300 giri/min	Diametro interno tubo aria	10 mm
Consumo medio aria	200 l/min	Peso	3,8 kg



1.700 Nm
5,6 kg

928 D1 3/4" 3/4"

Cod. U09280015

Avvitatore ad impulsi in alluminio

~~€ 713,00~~ | **€ 499,00**

CARATTERISTICHE TECNICHE

Attacco quadro	3/4"	Pressione aria raccomandata	6,2 bar
Capacità bullone	M24	Pressione sonora	98,4±3 dB(A)
Coppia massima	1.700 Nm	Potenza sonora	109,4±3 dB(A)
Coppia di lavoro	500÷1.050 Nm	Vibrazioni	9,1 m/s ²
Impulsi al minuto	790	Attacco aria	3/8"
Velocità a vuoto	5.700 giri/min	Diametro interno tubo aria	13 mm
Consumo medio aria	193 l/min	Peso	5,6 kg



3.390 Nm
6,8 kg

942 PE1 1" 1"

Cod. U09420005

Avvitatore ad impulsi in materiale composito

~~€ 956,00~~ | **€ 669,00**

CARATTERISTICHE TECNICHE

Attacco quadro	1"	Pressione aria raccomandata	6,2 bar
Capacità bullone	M38	Pressione sonora	100,9 ±3 dB(A)
Coppia massima	3.390 Nm	Potenza sonora	111,9 ±3 dB(A)
Coppia di lavoro	203÷1.627 Nm	Vibrazioni	10,6 m/s ²
Impulsi al minuto	900	Attacco aria	1/2"
Velocità a vuoto	5.000 giri/min	Diametro interno tubo aria	19 mm
Consumo medio aria	400 l/min	Peso	6,8 kg



3.390 Nm
9 kg

942 PEL2 1" 1"

Cod. U09420007

Avvitatore reversibile in linea in materiale composito

~~€ 999,00~~ | **€ 699,00**

CARATTERISTICHE TECNICHE

Attacco quadro	1"	Pressione aria raccomandata	6,2 bar
Capacità bullone	M38	Pressione sonora	105 ±3 dB(A)
Coppia massima	3.390 Nm	Potenza sonora	116 ±3 dB(A)
Coppia di lavoro	203÷1.627 Nm	Vibrazioni	15,6 m/s ²
Impulsi al minuto	1000	Attacco aria	1/2"
Velocità a vuoto	5.000 giri/min	Diametro interno tubo aria	19 mm
Consumo medio aria	480 l/min	Peso	9 kg

152
mm

5
mm

105
l/min

COMPATTA
221 mm



920 AN1

Cod. U09200011

Levigatrice roto-orbitale

CARATTERISTICHE TECNICHE

Potenza	0,19 Kw
Capacità disco	Ø 152 mm
Orbita	5 mm
Orbite al minuto	10.000 giri/min
Consumo medio aria	105 l/min
Pressione aria raccomandata	6,2 bar
Pressione sonora	78,9±3 dB(A)
Potenza sonora	79,9±3 dB(A)
Vibrazioni	11,8 m/s ²
Attacco aria	1/4"
Diametro interno tubo aria	10 mm
Peso	0,8 kg



~~€ 284,00~~ | **€ 199,00**

10.000
Cicli/min

230
l/min

800
g



923 A

Cod. U09230001

Seghetto alternativo

CARATTERISTICHE TECNICHE

Cicli al minuto	10.000
Consumo medio aria	230 l/min
Attacco aria	1/4"
Pressione aria raccomandata	6,2 bar
Diametro interno tubo aria	10 mm
Pressione sonora	83,5±3 dB(A)
Potenza sonora	94,5±3 dB(A)
Vibrazioni	17,1 m/s ²
Peso	800 g



~~€ 231,00~~ | **€ 162,00**



125
mm

750 W

12.000
Giri/min

921 A4

Cod. U09210012

Smerigliatrice angolare

CARATTERISTICHE TECNICHE

Diametro disco	Ø 125 mm
Diametro attacco disco	Ø 24 mm
Potenza	0,75 Kw
Velocità a vuoto	12.000 giri/min
Consumo medio aria	120 l/min
Pressione aria raccomandata	6,2 bar
Pressione sonora	86±3 dB(A)
Potenza sonora	94±3 dB(A)
Vibrazioni	2,5 m/s ²
Attacco aria	1/4"
Peso	1,9 Kg



~~€ 284,00~~ | **€ 199,00**

CAVO 16 m
Ø 10 mm

939 C1

Cod. U09390004

Avvolgitubo aria

CARATTERISTICHE TECNICHE

Lunghezza tubo	16 m
Diametro interno tubo	10 mm
Pressione max di utilizzo	15 bar
Raccordo in uscita	3/8"
Dimensioni (inclusa staffa)	450x400x230 mm
Peso	8 kg



~~€ 283,00~~ | **€ 198,00**

30.000 Giri/min



922 B1

Cod. U09220001

Smerigliatrice dritta

CARATTERISTICHE TECNICHE

Consumo medio aria	76 l/min	Vibrazioni	2,42 m/s ²
Pressione aria raccomandata	6,2 bar	Attacco aria	1/4"
Pressione sonora	84,8±3 dB(A)	Diametro interno tubo aria	10 mm
Potenza sonora	99,5±3 dB(A)	Peso	440 g

~~€ 99,00~~ | € 69,00

25.000 Giri/min



922 B2

Cod. U09220002

Smerigliatrice dritta alta potenza

CARATTERISTICHE TECNICHE

Consumo medio aria	113 l/min	Vibrazioni	1,86 m/s ²
Pressione aria raccomandata	6,2 bar	Attacco aria	1/4"
Pressione sonora	85,4±3 dB(A)	Diametro interno tubo aria	10 mm
Potenza sonora	99,8±3 dB(A)	Peso	675 g

~~€ 113,00~~ | € 79,00

23.000 Giri/min



90°



922 BP1

Cod. U09220004

Smerigliatrice angolare 90°

CARATTERISTICHE TECNICHE

Consumo medio aria	76 l/min	Vibrazioni	4,54 m/s ²
Pressione aria raccomandata	6,2 bar	Attacco aria	1/4"
Pressione sonora	85,9±3 dB(A)	Diametro interno tubo aria	10 mm
Potenza sonora	96,9±3 dB(A)	Peso	555 g

~~€ 141,00~~ | € 99,00

24.000 Giri/min



120°



922 BR1

Cod. U09220005

Smerigliatrice angolare 120°

CARATTERISTICHE TECNICHE

Consumo medio aria	76 l/min	Vibrazioni	5,22 m/s ²
Pressione aria raccomandata	6,2 bar	Attacco aria	1/4"
Pressione sonora	84,8±3 dB(A)	Diametro interno tubo aria	10 mm
Potenza sonora	95,8±3 dB(A)	Peso	560 g

~~€ 141,00~~ | € 99,00

28.000 Giri/min



922 BL1

Cod. U09220003

Smerigliatrice mandrino lungo

CARATTERISTICHE TECNICHE

Consumo medio aria	76 l/min	Vibrazioni	2,86 m/s ²
Pressione aria raccomandata	6,2 bar	Attacco aria	1/4"
Pressione sonora	83,3±3 dB(A)	Diametro interno tubo aria	10 mm
Potenza sonora	94,3±3 dB(A)	Peso	664 g

~~€ 141,00~~ | € 99,00

NEW



6
PEZZI

1 1/2"

↔ 210
↓ 60
mm ↗ 130

233 1/2" MNTX/C6

Cod. U02332514



Assortimento in cassetta di ABS con bussole per viti con impronta TORX®

DESCRIZIONE	ART./MISURA	PZ.
Chiavi a bussola macchina per viti con impronta TORX®	233 1/2 MNTX T30-T40-T45-T50-T55-T60	6

~~€ 94,60~~ | **€ 66,50**



16
PEZZI

1 1/2"

↔ 210
↓ 60
mm ↗ 130

687 1/2" C16

Cod. U06870100



Assortimento in cassetta di ABS con inserti macchina

DESCRIZIONE	ART./MISURA	PZ.
Portainseriti	685 6 1/2	1
Portainseriti	685 8 5/16	1
Inserti esagono maschio 1/2	687 E 6-7-8-10-12-14	6
Inserti TORX 1/2	687 TX T30-T40-T45-T50-T55	5
Inserti PHILLIPS 5/16	686 PH 2-3-4	3

~~€ 147,00~~ | **€ 89,00**



6
PEZZI

3 3/4"

↔ 210
↓ 60
mm ↗ 130

688 3/4" MD6

Cod. U06880010



Assortimento in cassetta di ABS con inserti macchina

DESCRIZIONE	ART./MISURA	PZ.
Portainseriti	685 B 1 7/8	1
Inserti esagono maschio 7/8	688 E 12-17-19-22-24	5

~~€ 191,00~~ | **€ 134,00**



Gamma porta inserti 685 B e inserti macchina 688

ANTICORROSIONE E ANTIUSURA

Acciaio al cromo molibdeno e fosfatazione al manganese.

ISO 9227

SPINA DI TENUTA

Garantisce maggior tenuta dell'inserto nella sede rispetto al grano di bloccaggio.

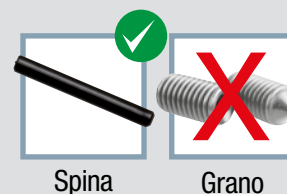

Spina

Grano

Modulare con i cassetti
dei carrelli USAG



NEW

235 1/2" M/C16

Cod. U02359285



Assortimento in cassetta modulare
con bussole macchina esagonali

DESCRIZIONE	ART./MISURA	PZ.
Chiavi a bussola macchina con bocca esagonale	235 1/2 M 10-12-13-14-15-16-17-18-19-21-22-24-27-30-32 mm	15
Spina di tenuta	235 MCA/4-6	2
Anello di sicurezza	235 MDA/4-6	2
Prolunghe macchina	236 1/2 M/125	1

16
PEZZI

1 1/2"

~~€ 200,70~~ | € 99,00

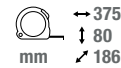

7
PEZZI

3 3/4"

235 3/4" M/D7

Cod. U02359284



Assortimento in cassetta di metallo
con bussole macchina

DESCRIZIONE	ART./MISURA	PZ.
Chiavi a bussola macchina con bocca esagonale	235 3/4 M 17-19-22-24-27-30-32	7

~~€ 174,00~~ | € 122,00

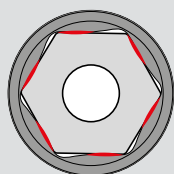
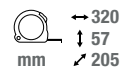

ISO 2725-2
ISO 1174-2

Gamma bussole esagonali macchina

PROFILO MIGLIORATO

Maggiore contatto tra bussola e superficie piana di dado o vite.

ESECUZIONE FOSFATATA

ISO 9227

MARCATURA LASER

Logo e misura più visibile (misure 1" e 1 1/2" per incisione).

ACCIAIO SPECIALE

Cromo molibdeno per superiore resistenza agli impatti.

IL CATALOGO COMPLETO A PORTATA DI MANO E SEMPRE AGGIORNATO!

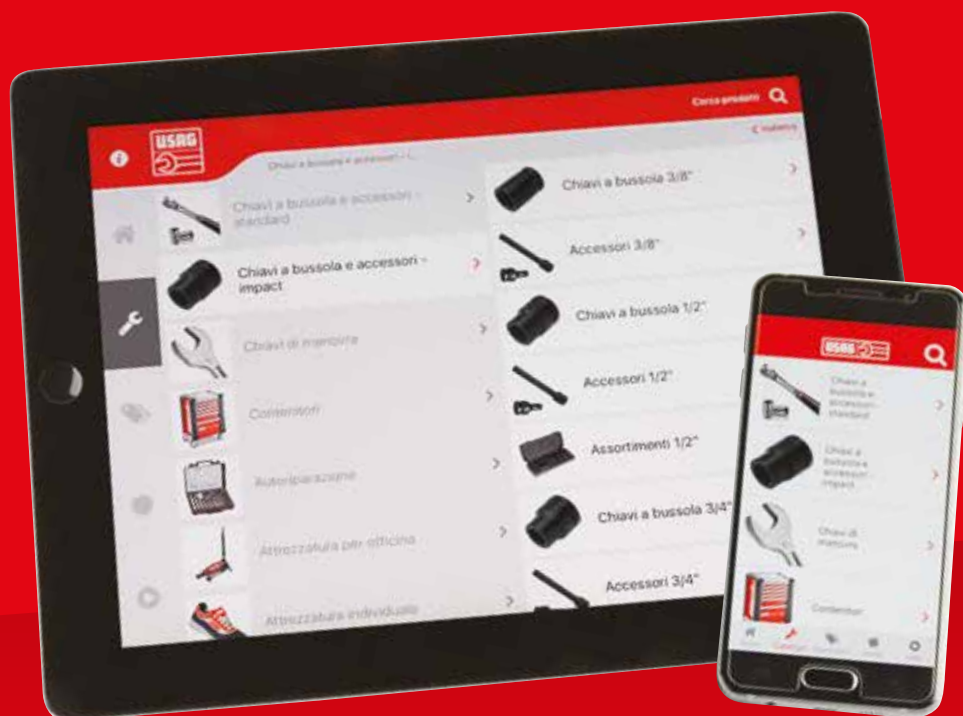

Scarica l'App!

- Funziona offline.
- Notifiche push.
- Leggera.



SU SMARTPHONE E TABLET.



Stanley Black & Decker Italia S.r.l.
Via Volta, 3 - 21020 Monvalle (VA)
Tel. +39 0332 790111
Fax +39 0332 790330
info.mv@usag.it

usag.it



Offerta valida fino al 31 gennaio 2022 salvo esaurimento scorte, presso i Rivenditori che aderiscono all'iniziativa. Tutti i prezzi sono da intendersi in Euro, IVA esclusa. Le immagini riprodotte in questa brochure sono indicative. Stanley Black & Decker Italia S.r.l. si riserva in ogni momento di modificare le caratteristiche tecniche dei prodotti.

TIMBRO DEL RIVENDITORE